

DATA SHEET

METAL OXIDE VARISTORS POWER SUPPLY

07D series

RoHS compliant & Halogen free



Product specification— May 08, 2021 V.2



Metal Oxide Varistors (MOV) Data Sheet

Features

- Wide operating voltage (V_{1mA}) range from 18V to 820V
- Fast responding to transient over-voltage
- Large absorbing transient energy capability
- Low clamping ratio and no follow-on current
- Meets MSL level 1, per J-STD-020
- Operating Temperature: $-40^{\circ}\text{C} \sim +105^{\circ}\text{C}$
- Storage Temperature: $-40^{\circ}\text{C} \sim +125^{\circ}\text{C}$
- Safety certification: UL、CSA、VDE



Applications

- Transistor, diode, IC, thyristor or triac semiconductor protection
- Surge protection in consumer electronics
- Surge protection in industrial electronics
- Surge protection in electronic home appliances, gas and petroleum appliances
- Relay and electromagnetic valve surge absorption

Part Number Code

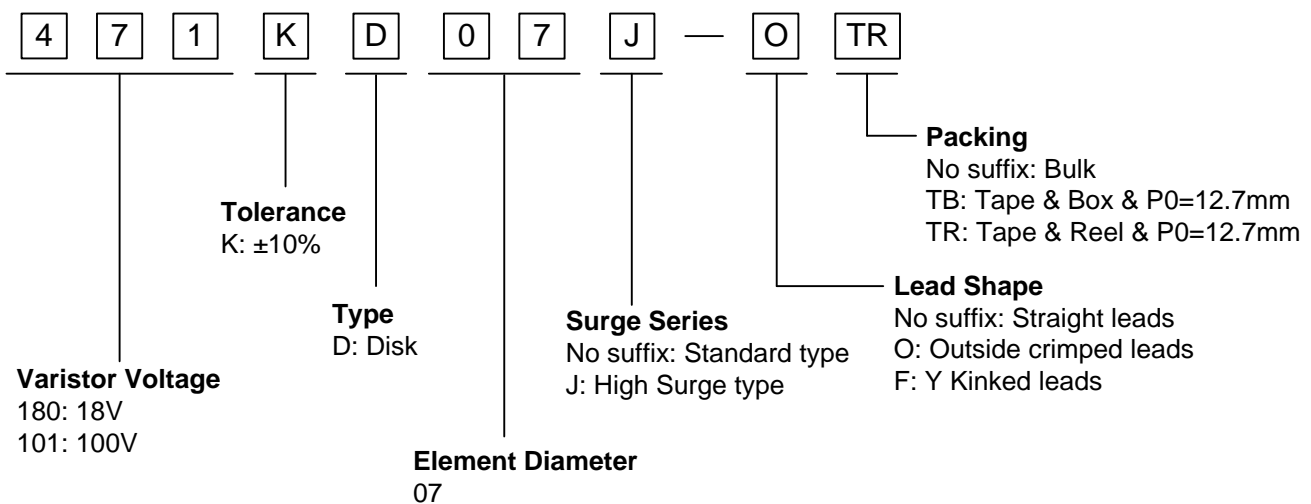

Dimensions

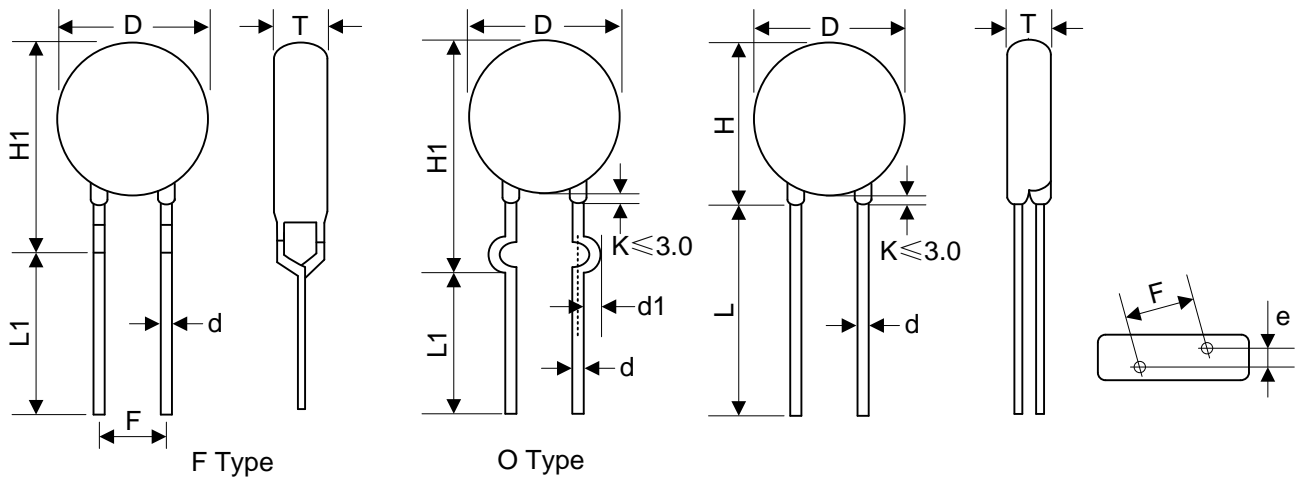

Table 1	
Unit: mm	
Symbol	Dimension
H	7.5~12.0
H1	9.0~13.5
L(min.)	20.0
L1(min.)	15.0
D	7.0~9.0
F(±0.8)	5.0
T	Table 2
e(±0.8)	Table 2
d(±0.05)	0.6
d1(±0.4)	1.2

Table 2					
Unit: mm					
Model	T	e	Model	T	e
180K	1.5~4.5	1.3	241K	2.1~4.6	2.0
220K	1.6~4.6	1.4	271K	2.1~4.9	2.2
270K	1.6~4.7	1.6	301K	2.2~5.0	2.3
330K	1.7~4.9	1.5	331K	2.2~5.1	2.3
390K	1.6~4.8	1.6	361K	2.4~5.2	2.5
470K	1.7~4.9	1.7	391K	2.5~5.4	2.6
560K	1.8~5.0	1.9	431K	2.7~5.7	2.8
680K	1.9~5.2	2.2	471K	2.8~6.0	3.0
820K	1.6~4.1	1.6	511K	2.9~6.2	3.2
101K	1.9~4.3	1.8	561K	3.1~6.5	3.4
121K	1.9~4.5	2.0	621K	3.3~7.1	3.7
151K	1.7~4.8	1.6	681K	3.5~7.3	4.0
181K	1.8~4.3	1.7	751K	3.8~7.0	4.1
201K	1.9~4.4	1.8	781K	3.9~7.2	4.2
221K	2.0~4.5	1.9	821K	4.1~7.5	4.4

METAL OXIDE VARISTORS

07D

Electrical Characteristics

Part Number		Maximum Allowable Voltage		Varistor Voltage	Maximum Clamping Voltage		Withstanding Surge Current		Maximum Energy (10/1000µs)		Rated Power	Typical Capacitance (Reference)
Standard	High Surge	V _{AC} (V)	V _{DC} (V)	V _{1mA} (V)	I _P (A)	V _C (V)	I (A) Standard	I (A) High Surge	(J) Standard	(J) High Surge	(W)	@ 1KHz (pf)
180KD07	180KD07J	11	14	18(15~21.6)	2.5	36	250	500	0.9	2.0	0.02	2800
220KD07	220KD07J	14	18	22(19.5~26)	2.5	43	250	500	1.1	2.4	0.02	2300
270KD07	270KD07J	17	22	27(24~31)	2.5	53	250	500	1.4	3.0	0.02	1800
330KD07	330KD07J	20	26	33(29.5~36.5)	2.5	65	250	500	1.7	3.5	0.02	1500
390KD07	390KD07J	25	31	39(35~43)	2.5	77	250	500	2.1	4.0	0.02	1300
470KD07	470KD07J	30	38	47(42~52)	2.5	93	250	500	2.5	5.0	0.02	1100
560KD07	560KD07J	35	45	56(50~62)	2.5	110	250	500	3.1	6.0	0.02	890
680KD07	680KD07J	40	56	68(61~75)	2.5	135	250	500	3.6	7.0	0.02	740
820KD07	820KD07J	50	65	82(74~90)	10	135	1200	1750	5	10.0	0.25	600
101KD07	101KD07J	60	85	100(90~110)	10	165	1200	1750	6.5	12.0	0.25	500
121KD07	121KD07J	75	100	120(108~132)	10	200	1200	1750	7.8	13.0	0.25	420
151KD07	151KD07J	95	125	150(135~165)	10	250	1200	1750	9.7	15.0	0.25	330
181KD07	181KD07J	115	150	180(162~198)	10	300	1200	1750	11.7	16.0	0.25	280
201KD07	201KD07J	130	170	200(180~220)	10	340	1200	1750	13.0	17.0	0.25	250
221KD07	221KD07J	140	180	220(198~242)	10	360	1200	1750	14.0	19.0	0.25	230
241KD07	241KD07J	150	200	240(216~264)	10	395	1200	1750	15.0	21.0	0.25	210
271KD07	271KD07J	175	225	270(243~297)	10	455	1200	1750	18.0	24.0	0.25	185
301KD07	301KD07J	190	250	300(270~330)	10	500	1200	1750	20.0	26.0	0.25	165
331KD07	331KD07J	210	275	330(297~363)	10	550	1200	1750	23.0	28.0	0.25	150
361KD07	361KD07J	230	300	360(324~396)	10	595	1200	1750	24.0	32.0	0.25	140
391KD07	391KD07J	250	320	390(351~429)	10	650	1200	1750	26.0	35.0	0.25	130
431KD07	431KD07J	275	350	430(387~473)	10	710	1200	1750	28.0	40.0	0.25	115
471KD07	471KD07J	300	385	470(423~517)	10	775	1200	1750	29.0	42.0	0.25	105
511KD07	511KD07J	320	415	510(459~561)	10	845	1200	1750	31.0	45.0	0.25	100
561KD07	561KD07J	350	460	560(504~616)	10	925	1200	1750	35.0	49.0	0.25	90
621KD07	621KD07J	385	505	620(558~682)	10	1025	1200	1750	38.0	55.0	0.25	80
681KD07	681KD07J	420	560	680(612~748)	10	1120	1200	1750	42.0	60.0	0.25	75
751KD07	751KD07J	460	615	750(675~825)	10	1240	1200	1750	45.0	64.0	0.25	70
781KD07	781KD07J	485	640	780(702~858)	10	1290	1200	1750	48.0	69.0	0.25	65
821KD07	821KD07J	510	670	820(738~902)	10	1355	1200	1750	52.0	73.0	0.25	60

Notes: 1. The tolerance of varistor voltage between 18V and 27V is more than 10%.

2. Leakage Current (@83% of V_{1mA}): IR≤50µA (180K~680K) IR≤25µA (820K~821K)

Maximum Surge Current Derating Curve

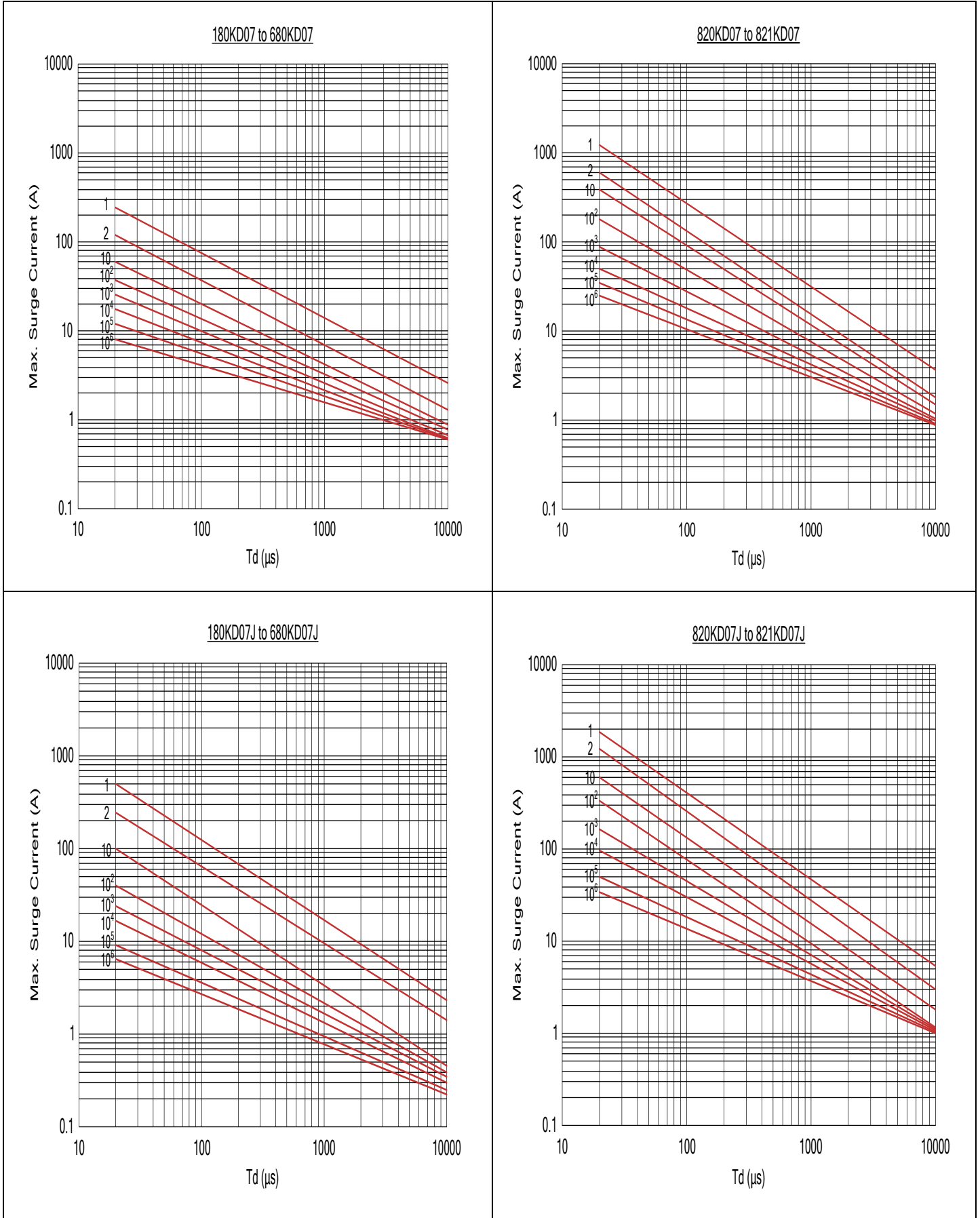

Maximum Leakage Current and Maximum Clamping Voltage Curve

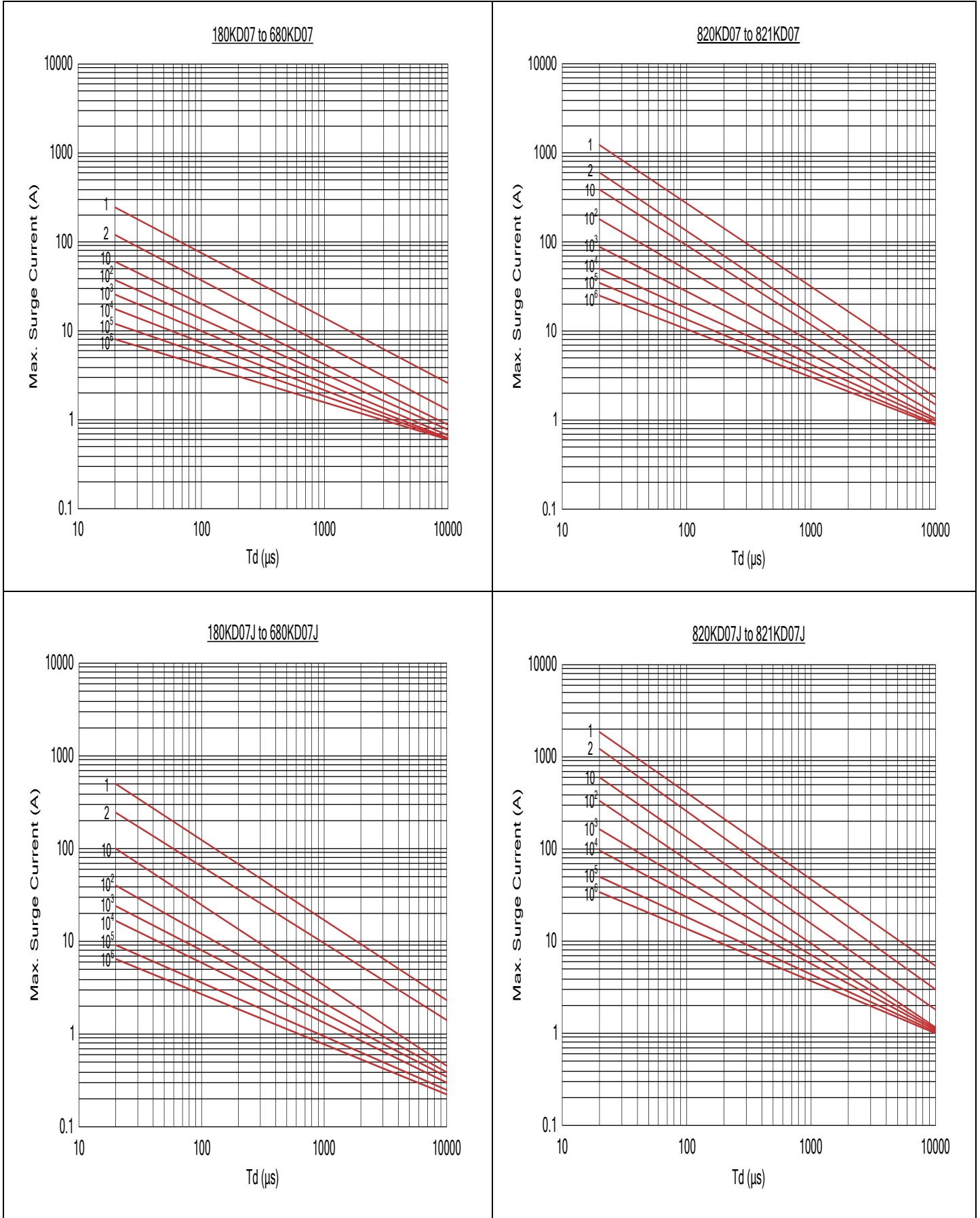

Maximum Leakage Current and Maximum Clamping Voltage Curve

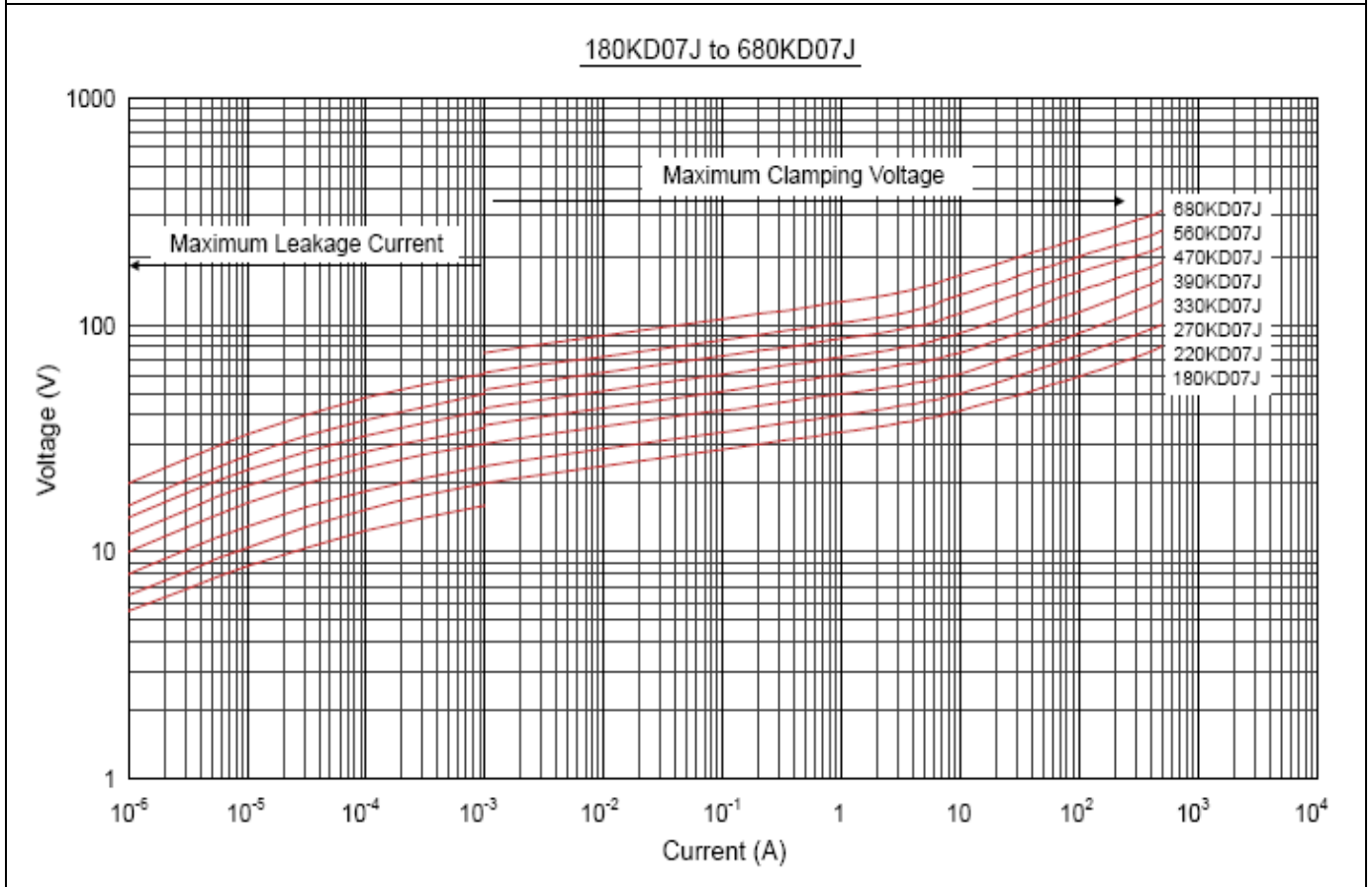
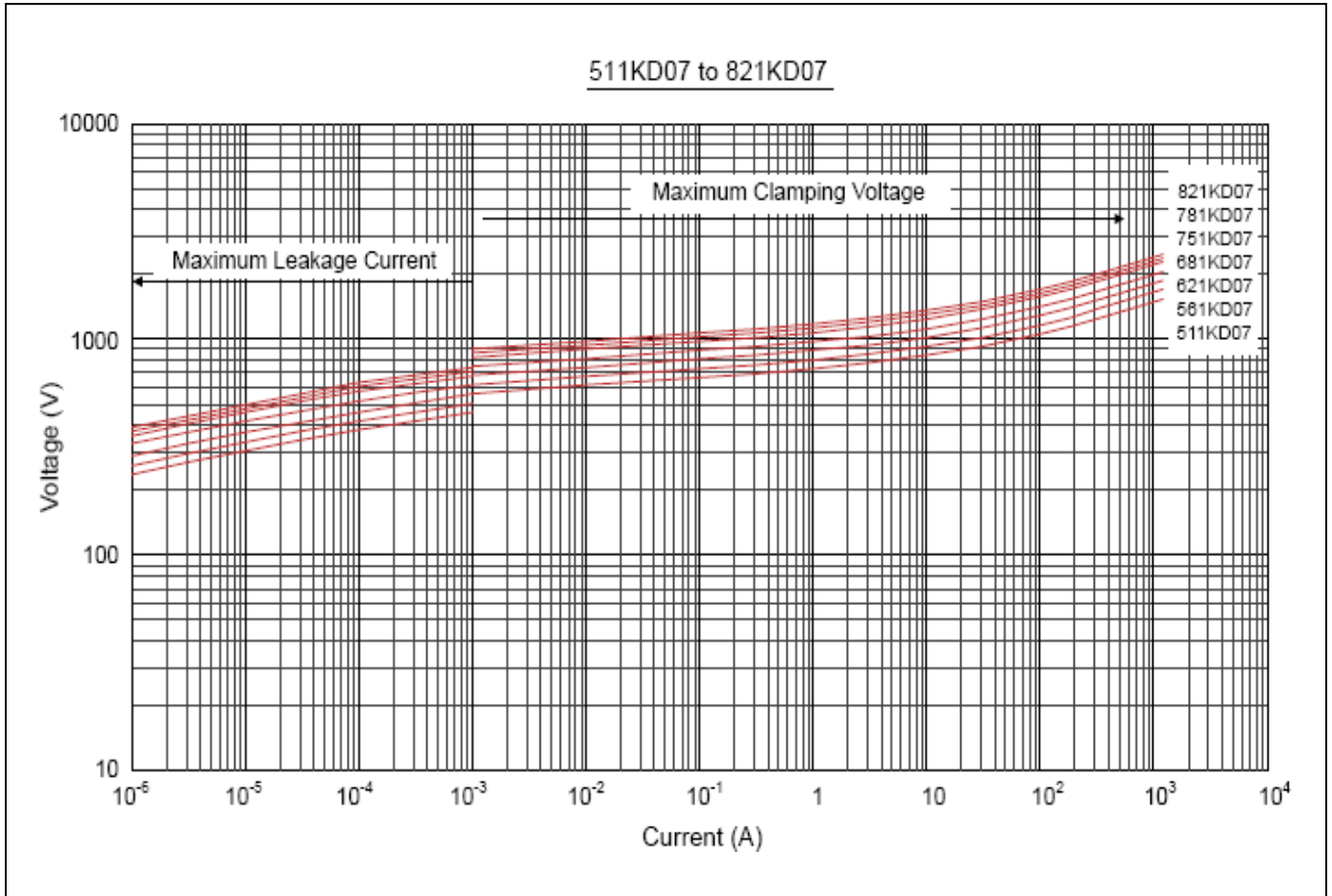

Maximum Leakage Current and Maximum Clamping Voltage Curve

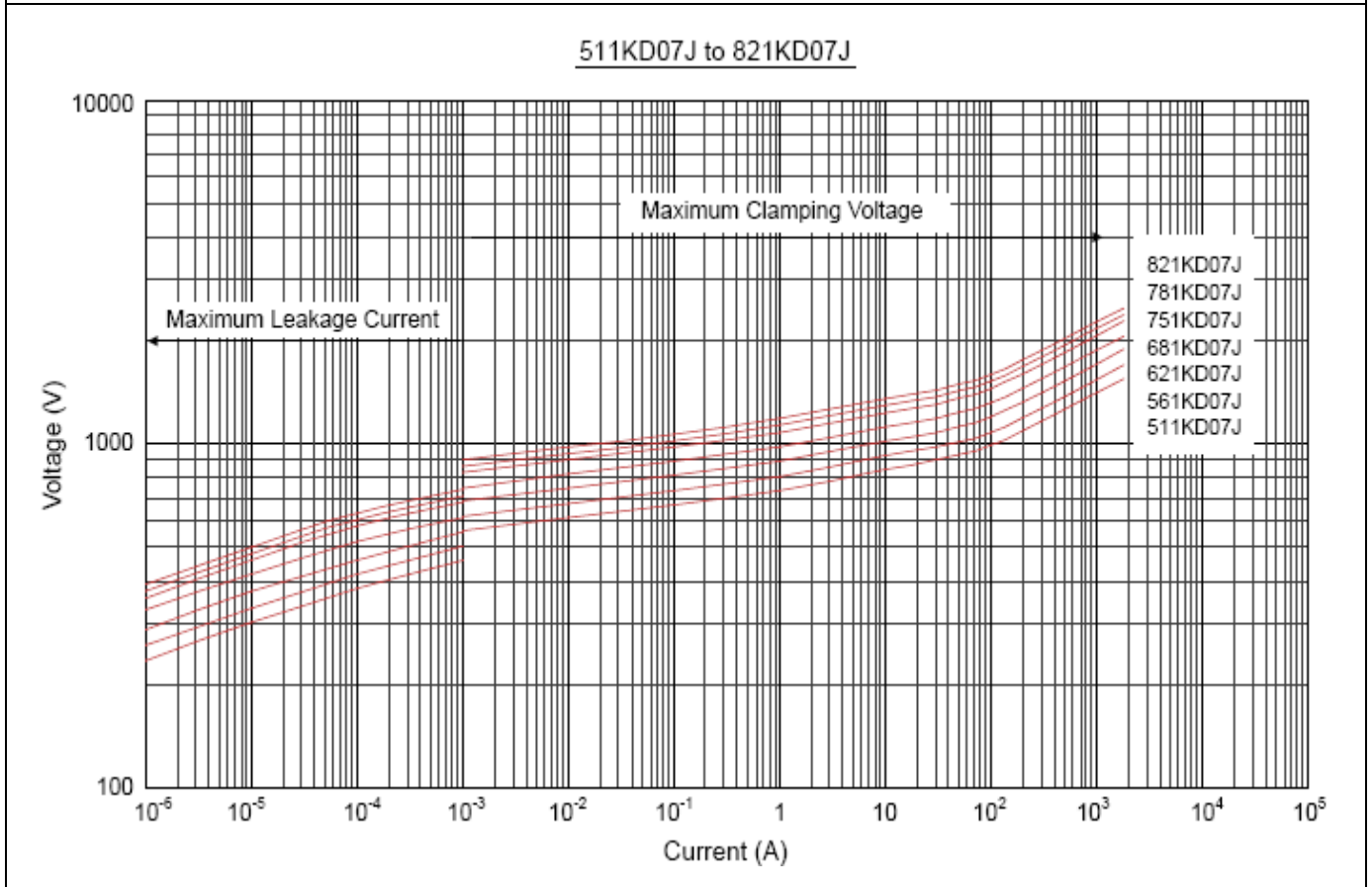
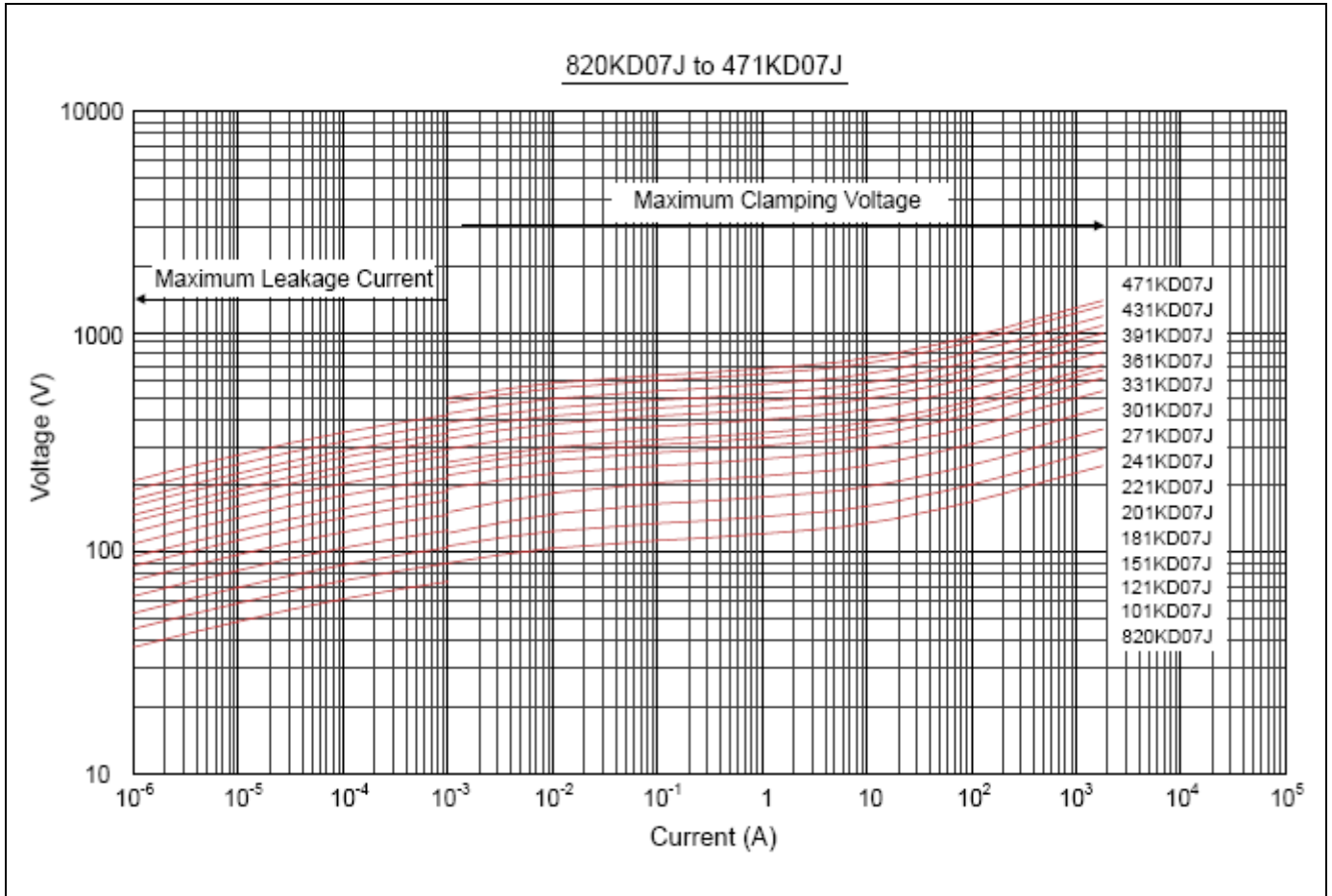

Reliability

Items	Standard	Test conditions / Methods	Specifications															
Tensile Strength of Terminals	IEC60068-2-21	Gradually applying the force specified and keeping the unit fixed for 10±1 sec. <table style="width: 100%; border-collapse: collapse;"> <tr> <td style="text-align: center; border-bottom: 1px solid black;">Terminal diameter (mm)</td> <td style="text-align: center; border-bottom: 1px solid black;">Force (kg)</td> </tr> <tr> <td style="text-align: center;">0.5 < d ≤ 0.8</td> <td style="text-align: center;">1.0</td> </tr> <tr> <td style="text-align: center;">0.8 < d ≤ 1.25</td> <td style="text-align: center;">2.0</td> </tr> <tr> <td style="text-align: center;">1.25 < d</td> <td style="text-align: center;">4.0</td> </tr> </table>	Terminal diameter (mm)	Force (kg)	0.5 < d ≤ 0.8	1.0	0.8 < d ≤ 1.25	2.0	1.25 < d	4.0	No visible damage ΔV _{1mA} /V _{1mA} ≤ 5%							
Terminal diameter (mm)	Force (kg)																	
0.5 < d ≤ 0.8	1.0																	
0.8 < d ≤ 1.25	2.0																	
1.25 < d	4.0																	
Bending Strength of Terminals	IEC60068-2-21	Hold specimen and apply the force specified below to each lead. Bend the specimen to 90°, then return to the original position. Repeat the procedure in the opposite direction. <table style="width: 100%; border-collapse: collapse;"> <tr> <td style="text-align: center; border-bottom: 1px solid black;">Terminal diameter (mm)</td> <td style="text-align: center; border-bottom: 1px solid black;">Force (kg)</td> </tr> <tr> <td style="text-align: center;">0.5 < d ≤ 0.8</td> <td style="text-align: center;">0.5</td> </tr> <tr> <td style="text-align: center;">0.8 < d ≤ 1.25</td> <td style="text-align: center;">1.0</td> </tr> <tr> <td style="text-align: center;">1.25 < d</td> <td style="text-align: center;">2.0</td> </tr> </table>	Terminal diameter (mm)	Force (kg)	0.5 < d ≤ 0.8	0.5	0.8 < d ≤ 1.25	1.0	1.25 < d	2.0	No visible damage ΔV _{1mA} /V _{1mA} ≤ 5%							
Terminal diameter (mm)	Force (kg)																	
0.5 < d ≤ 0.8	0.5																	
0.8 < d ≤ 1.25	1.0																	
1.25 < d	2.0																	
Vibration	IEC60068-2-6	Frequency range: 10~55 Hz Amplitude: 0.75mm or 98m/s ² Direction: 3 mutually perpendicular directions, 2hrs each.	No visible damage ΔV _{1mA} /V _{1mA} ≤ 5%															
Solderability	IEC60068-2-20	Solder Temp: 245±5°C Dipping Time: 2±0.5 sec	At least 95% of terminal electrode is covered by new solder															
Resistance to Soldering Heat	IEC60068-2-20	Solder Temp: 260±5°C Dipping Time: 10±1 sec	No visible damage ΔV _{1mA} /V _{1mA} ≤ 5%															
High Temperature Storage	IEC60068-2-2	Ambient Temp: 125±2°C Duration: 1000±24hrs	No visible damage ΔV _{1mA} /V _{1mA} ≤ 5%															
Low Temperature Storage	IEC60068-2-1	Ambient Temp: -40±2°C Duration: 1000±24hrs	No visible damage ΔV _{1mA} /V _{1mA} ≤ 5%															
Damp Heat, Steady State	IEC60068-2-78	The test is divided into two groups . a. 40±2°C , 90~95% RH for 1344±24hrs b. 40±2°C , 90~95% RH, at 10%VDC , 1344±24 hrs	No visible damage ΔV _{1mA} /V _{1mA} ≤ 10% Insulation Resistance ≥ 100MΩ															
High Temperature Load	MIL-STD-202 Method 108	Ambient Temp: 105±2°C Duration: 1000±24hrs Load: Max. Allowable Voltage In AC.	ΔV _{1mA} /V _{1mA} ≤ 10%															
Temperature Cycle	IEC60068-2-14	The conditions shown below shall be repeated 5 cycles <table border="1" style="width: 100%; border-collapse: collapse; margin-top: 10px;"> <thead> <tr> <th>Step</th> <th>Temperature (°C)</th> <th>Period (minutes)</th> </tr> </thead> <tbody> <tr> <td style="text-align: center;">1</td> <td style="text-align: center;">-40±3</td> <td style="text-align: center;">30±3</td> </tr> <tr> <td style="text-align: center;">2</td> <td style="text-align: center;">Room temperature</td> <td style="text-align: center;">5±3</td> </tr> <tr> <td style="text-align: center;">3</td> <td style="text-align: center;">125±3</td> <td style="text-align: center;">30±3</td> </tr> <tr> <td style="text-align: center;">4</td> <td style="text-align: center;">Room temperature</td> <td style="text-align: center;">5±3</td> </tr> </tbody> </table>	Step	Temperature (°C)	Period (minutes)	1	-40±3	30±3	2	Room temperature	5±3	3	125±3	30±3	4	Room temperature	5±3	No visible damage ΔV _{1mA} /V _{1mA} ≤ 5%
Step	Temperature (°C)	Period (minutes)																
1	-40±3	30±3																
2	Room temperature	5±3																
3	125±3	30±3																
4	Room temperature	5±3																
8/20uS Surge Life	IEC61051-1	8/20μS waveform, 10 surge currents, unipolar, interval 30secs, amplitude corresponding to max. surge current derating curves for 20μS.	No visible damage ΔV _{b(1mA)} ≤ ±10%															
10/1000μS Surge Life	IEC61051-1	10/1000μS waveform, 10 surge currents, unipolar, interval 2mins, amplitude corresponding to max. surge current derating curves for 1000μS.	No visible damage ΔV _{1mA} /V _{1mA} ≤ 10%															
Voltage Proof	IEC61051-1	Metal balls method, 2500Vac 1 min.	No visible damage															

Soldering Recommendation

Lead-free Wave Soldering Recommendation

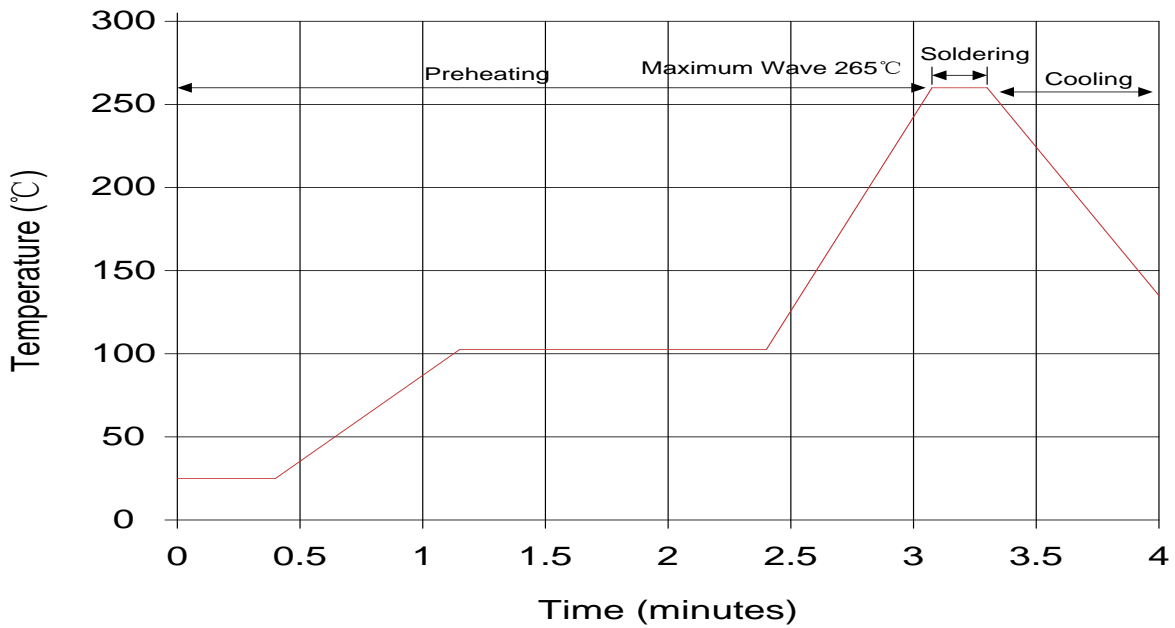

Item	Conditions
Peak Temperature	265°C
Dipping Time	10 seconds (max.)
Soldering	1 time

Recommendation Reworking Conditions with Soldering Iron

Item	Conditions
Temperature of Soldering Iron-tip	360°C (max.)
Soldering Time	3 seconds (max.)
Distance from Varistor	2mm (min.)

Marking Code

- ① Brightking Logo
- ② Varistor Voltage
- ③ UL Accreditation Logo
- ④ VDE Accreditation Logo
- ⑤ “J” is High Surge Code, no “J” is Standard Surge
- ⑥ Disk Size
- ⑦ Internal control code

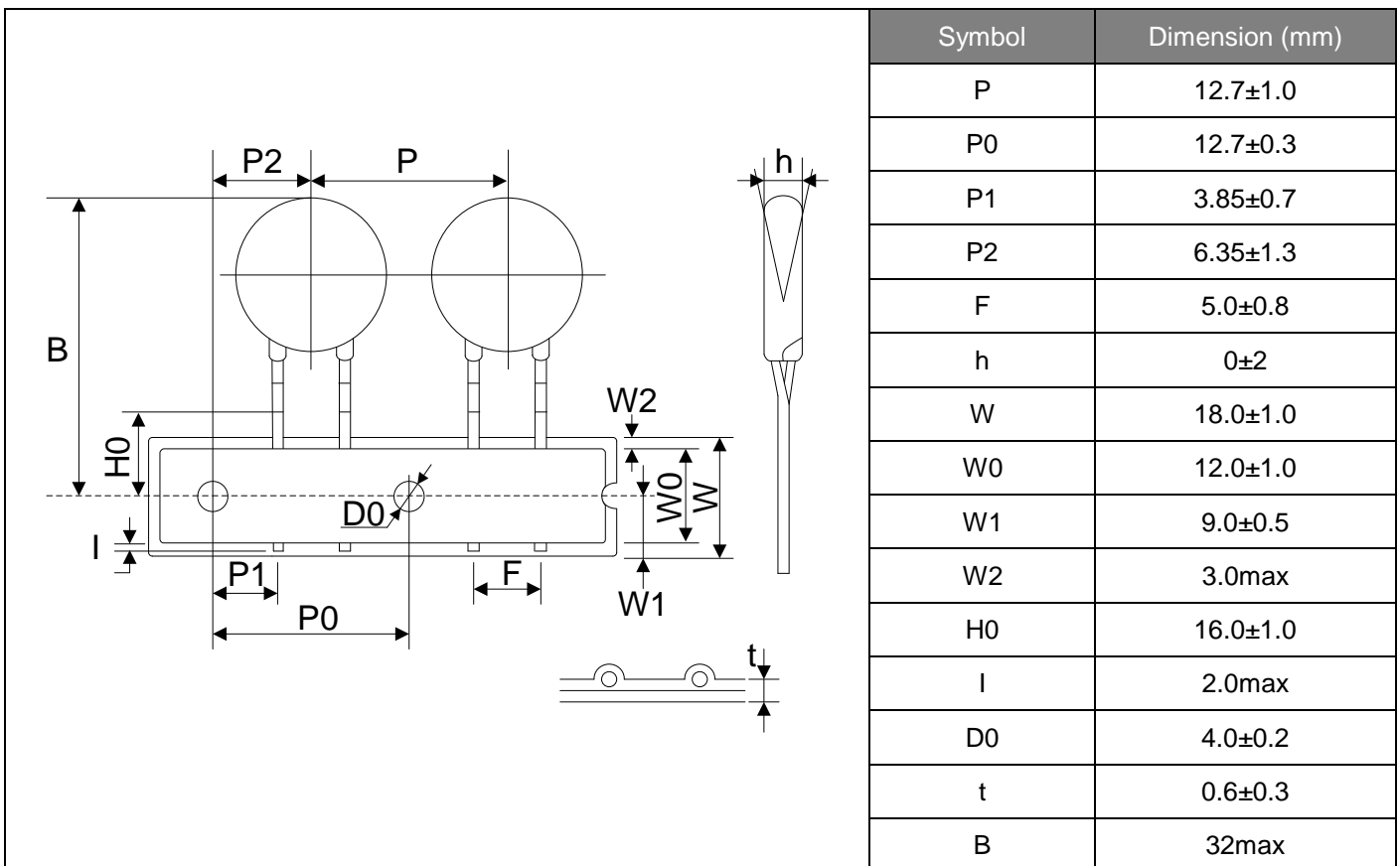
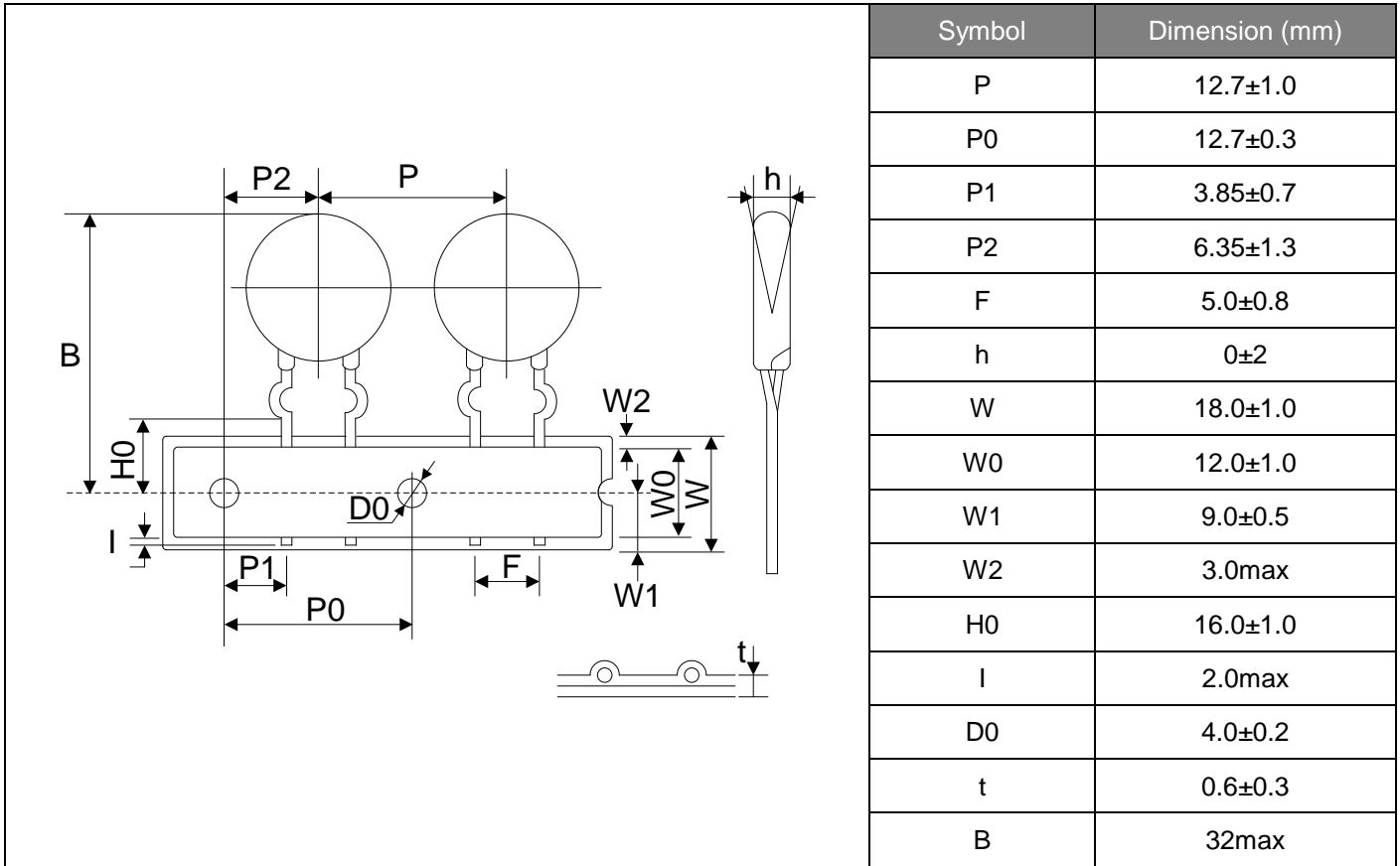

Taping Dimensions



Taping Dimensions

Symbol	Dimension (mm)
P	12.7±1.0
P0	12.7±0.3
P1	3.85±0.7
P2	6.35±1.3
F	5.0±0.8
h	0±2
W	18.0±1.0
W0	12.0±1.0
W1	9.0±0.5
W2	3.0max
H2	20.0±2.0
l	2.0max
D0	4.0±0.2
t	0.6±0.3
B	32max

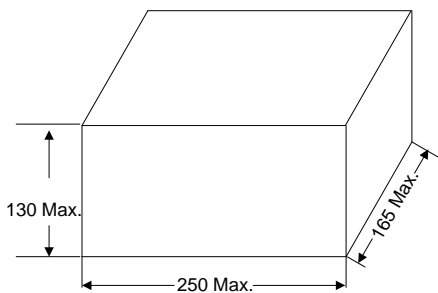
Quantity

Packaging Dimensions (Unit: mm)	Quantity
<p>In bulk for Terminals Untrimmed Products</p> 	<p>1000pcs/bag 4bags/box (180K~821K)</p>
<p>In bulk for Terminals Trimmed Products</p> 	<p>1000pcs/bag 4bags/box (180K~821K)</p>

Quantity

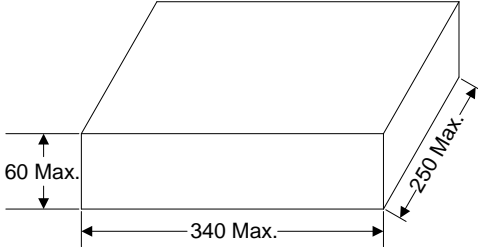
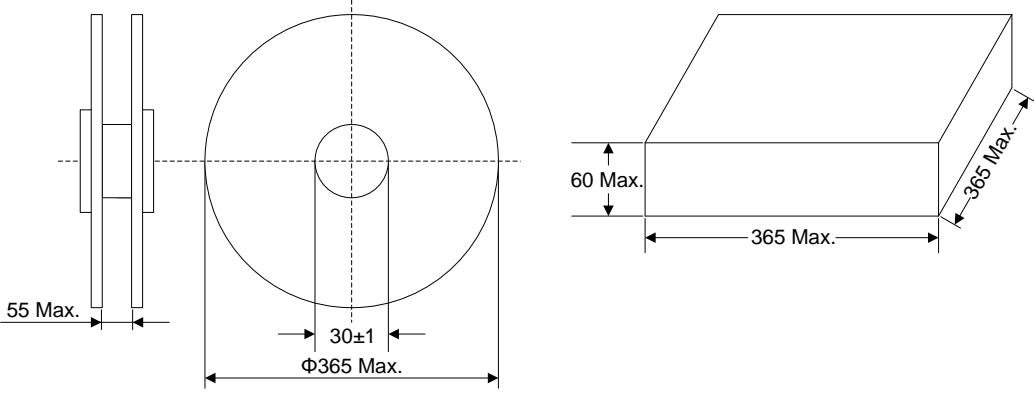
Packaging Dimensions (Unit: mm)	Quantity
<p>Tape & Box & P0=12.7mm</p> 	<p>1500pcs/box (180K~391K)</p> <p>1000pcs/box (431K~681K)</p> <p>750pcs/box (751K~821K)</p>
<p>Tape & Reel & P0=12.7mm</p> 	<p>2000pcs/reel (180K~331K)</p> <p>1500pcs/reel (361K~821K)</p>

Storage Condition of Products

(I) Storage Conditions :

- 1.Storage Temperature : -10°C ~ +40°C
- 2.Relative Humidity : ≦ 80%RH
- 3.Keep away from corrosive atmosphere and sunlight.

(II) Period of Storage : 1 year