

Si1153 Data Short

Proximity/Ambient Light Sensor IC with I²C Interface

The Si1153-AA00/AA09/AA9x is an ambient light sensor, proximity, and gesture detector with I²C digital interface and programmable-event interrupt output.

This touchless sensor IC includes dual 23-bit analog-to-digital converters, an integrated high-sensitivity array of visible and infrared photodiodes, a digital signal processor, and three integrated LED drivers with programmable drive levels. The Si1153 offers excellent performance under a wide dynamic range and a variety of light sources, including direct sunlight. The Si1153 can also work under dark glass covers. The photodiode response and associated digital conversion circuitry provide excellent immunity to artificial light flicker noise and natural light flutter noise. With two or more LEDs, the Si1153 is capable of supporting multiple-axis proximity motion detection. The Si1153 is provided in a 10-lead 2x2 mm DFN package or in a 10-lead 2.9x4.9 mm LGA module with integrated LED, and is capable of operation from 1.62 to 3.6 V over the -40 to +85 °C temperature range.

Applications:

- Wearables
- Handsets
- Display backlighting control
- Consumer electronics

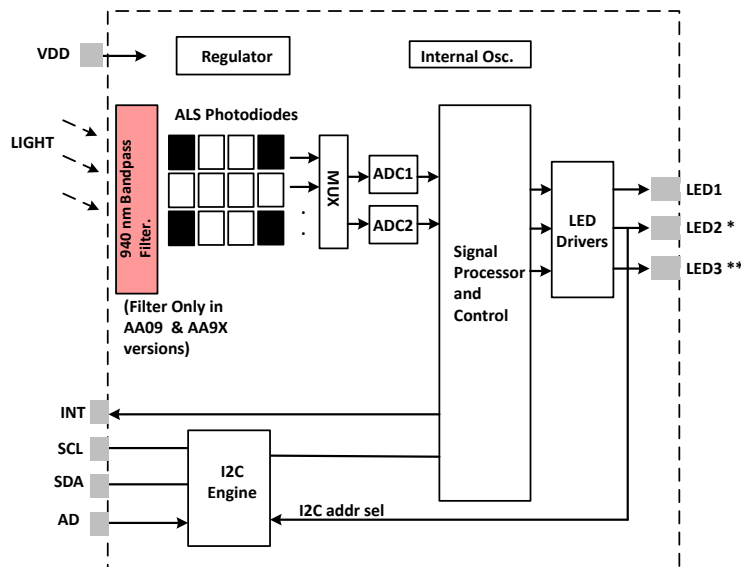

* Pull up to VDD with 47 kOhm resistor to select primary I2C address (0x53), or down to GND for alt I2C address 0x52.
 ** Pull up to VDD with 47 kOhm resistor

KEY FEATURES

- Proximity detector
 - From under 1 cm to 50 cm without additional lensing.
 - From under 1 cm to 200 cm with additional lensing (e.g. 5 mm hemispherical lens as in our EVB).
 - Up to three independent LED drivers.
 - 30 current settings from 5.6 mA to 360 mA for each LED driver.
 - Operates in direct sunlight with optional on-die 940 nm passband filter.
 - On die 940 nm bandpass filter that rejects unwanted visible light and IR from daylight and other sources (Si1153-AA09/AA9X).
- Ambient light sensor
 - <100 mlx resolution possible, allowing operation under dark glass.
 - Up to 128 klx dynamic range possible across two ADC range settings.
- Industry's lowest power consumption
 - 1.62 to 3.6 V supply voltage.
 - 9 µA average current (LED pulsed 25.6 µs every 800 ms at 180 µA plus 3 mA Si1153 supply).
 - <500 nA standby current.
 - 25.6 µs LED "on" time keeps total power consumption duty cycle low without compromising performance or noise community.
- Internal and external wake support.
- Built-in voltage supply monitor and power-on reset controller.
- Trimmable internal oscillator with typical 1% accuracy.
- I²C Serial communications
 - Up to 3.4 Mbps data rate.
 - Slave mode hardware address decoding.
- Two package options:
 - 10-lead 2 x 2 x 0.65 mm DFN
 - 10-lead 2.9 x 4.9 x 1.2 mm LGA module with integrated 940 nm LED
- Temperature Range: -40 to +85°C

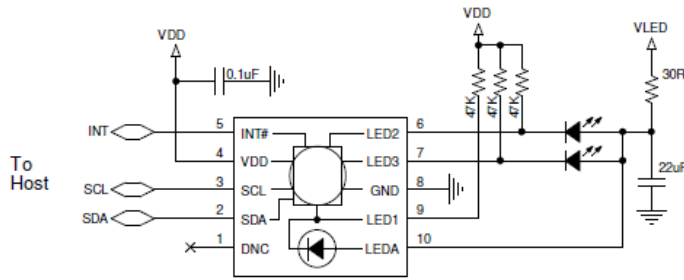

Si1153 LGA Module Basic Application

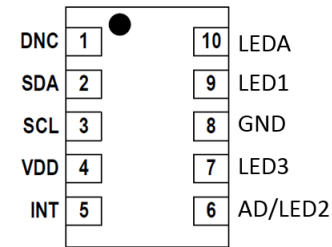

Pin Description 2.85x4.9 mm LGA Module

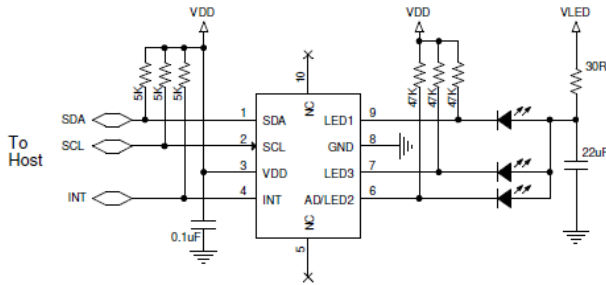

Si1153 DFN Basic Application

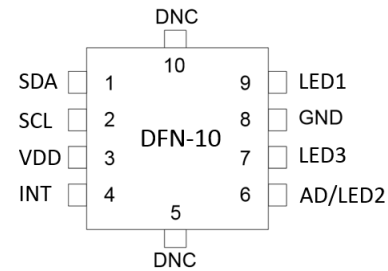

Pin Description 2x2 mm DFN

Table 1.1. Recommended Operating Conditions

Parameter	Symbol	Condition	Min	Typ	Max	Unit
V _{DD} Supply Voltage	V _{DD}		1.62	—	3.6	V
V _{DD} OFF Supply Voltage	V _{DD_OFF}	OFF mode	-0.3		1.0	V
V _{DD} Supply Ripple Voltage		V _{DD} = 3.3 V 1 kHz – 10 MHz	—	—	50	mVpp
Operating Temperature	T		-40	25	85	°C
SCL, SDA, Input High Logic Voltage	I ² C _{VIH}		V _{DD} × 0.7	—	V _{DD}	V
SCL, SDA Input Low Logic Voltage	I ² C _{VIL}		0	—	V _{DD} × 0.3	V
Start-Up Time		V _{DD} above 1.62 V	25	—	—	ms

Table 1.2. Ordering Guide

Family	DFN OPNs	Package	ALS	940 nm Filter	Proximity (# of LED Drivers)	# of LEDs Included
Si1153	Si1153-AA00-GMR	2 x 2 mm DFN	Y		3	0
Si1153	Si1153-AA09-GMR	2 x 2 mm DFN		Y	3	0
Si1153	Si1153-AA9x-GMR	2.85 x 4.9 mm LGA Module		Y	3	1

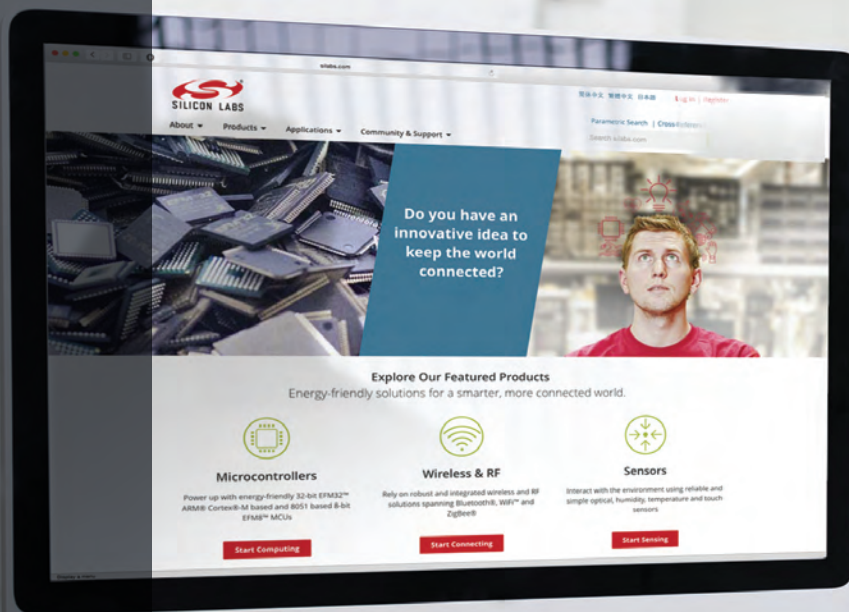

Smart.
Connected.
Energy-Friendly



Products
www.silabs.com/products

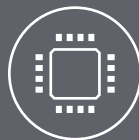

Quality
www.silabs.com/quality



Support and Community
community.silabs.com

Disclaimer

Silicon Laboratories intends to provide customers with the latest, accurate, and in-depth documentation of all peripherals and modules available for system and software implementers using or intending to use the Silicon Laboratories products. Characterization data, available modules and peripherals, memory sizes and memory addresses refer to each specific device, and "Typical" parameters provided can and do vary in different applications. Application examples described herein are for illustrative purposes only. Silicon Laboratories reserves the right to make changes without further notice and limitation to product information, specifications, and descriptions herein, and does not give warranties as to the accuracy or completeness of the included information. Silicon Laboratories shall have no liability for the consequences of use of the information supplied herein. This document does not imply or express copyright licenses granted hereunder to design or fabricate any integrated circuits. The products must not be used within any Life Support System without the specific written consent of Silicon Laboratories. A "Life Support System" is any product or system intended to support or sustain life and/or health, which, if it fails, can be reasonably expected to result in significant personal injury or death. Silicon Laboratories products are generally not intended for military applications. Silicon Laboratories products shall under no circumstances be used in weapons of mass destruction including (but not limited to) nuclear, biological or chemical weapons, or missiles capable of delivering such weapons.

Trademark Information

Silicon Laboratories Inc., Silicon Laboratories, Silicon Labs, SiLabs and the Silicon Labs logo, CMEMS®, EFM, EFM32, EFR, Energy Micro, Energy Micro logo and combinations thereof, "the world's most energy friendly microcontrollers", Ember®, EZLink®, EZMac®, EZRadio®, EZRadioPRO®, DSPLL®, ISOmodem®, Precision32®, ProSLIC®, SiPHY®, USBXpress® and others are trademarks or registered trademarks of Silicon Laboratories Inc. ARM, CORTEX, Cortex-M3 and THUMB are trademarks or registered trademarks of ARM Holdings. Keil is a registered trademark of ARM Limited. All other products or brand names mentioned herein are trademarks of their respective holders.



Silicon Laboratories Inc.
400 West Cesar Chavez
Austin, TX 78701
USA

<http://www.silabs.com>