

LUXEON 3535 2D

High flux in a 3535 package with full range of CCTs and CRIs

LUXEON 3535 2D is a mid-power LED delivering optimized performance in combination with the Quality of Light needed for distributed light source applications. In addition, the product comes in specified correlated color temperature and color rendering combinations for high brightness systems while improving system lm/\$. LUXEON 3535 2D emitters deliver the efficacy and reliability required by the indoor and outdoor illumination markets.



FEATURES AND BENEFITS

Industry standard package enables drop-in replacement for existing 3535 packages

High efficacy for sustainable designs

80CRI minimum and R9>0 for quality indoor lighting

1/6th and 1/9th ANSI color binning delivers tight color control

Full range of CCTs and CRIs

PRIMARY APPLICATIONS

Architectural

Downlights

High Bay & Low Bay

Indoor Area Lighting

Lamps

Outdoor

Specialty Lighting

Spotlights

Table of Contents

| | |
|---|----|
| General Information | 2 |
| Part Number Nomenclature | 2 |
| Average Lumen Maintenance Characteristics | 2 |
| Environmental Compliance | 2 |
| Product Selection | 3 |
| Optical Characteristics | 4 |
| Electrical Characteristics | 4 |
| Absolute Maximum Ratings | 5 |
| JEDEC Moisture Sensitivity | 5 |
| Reflow Soldering Characteristics | 6 |
| Mechanical Dimensions | 7 |
| Solder Pad Design | 8 |
| Assembly Precautions | 8 |
| Relative Spectral Distribution | 9 |
| Light Output Characteristics | 11 |
| Luminous Efficacy Characteristics | 12 |
| Forward Current Characteristics | 13 |
| Typical Radiation Patterns | 14 |
| Emitter Pocket Tape Packaging | 15 |
| Emitter Reel Packaging | 16 |
| Product Binning and Labeling | 17 |
| Color Bin Structure | 19 |

General Information

Part Number Nomenclature

LUXEON Mid-Power Illumination emitters are tested and binned at 100mA, with current pulse duration of 20ms. All characteristic charts where the thermal pad is kept at constant temperature (25°C typically) are measured with current pulse duration of 20ms. Under these conditions, junction temperature and thermal pad temperature are the same.

The part number designations for the MXCA series is explained as follows:

M X C A - B C D E - I J K L

Where:

- A — designates minimum CRI performance (value 7 = 70 minimum and 8 = 80 minimum)
- B — designates radiation pattern (value P = Lambertian)
- C — designates color (value W = White)
- D, E — designates nominal ANSI CCT (for example, 30 = 3000K and 40 = 4000K)
- I, J, K & L — additional part number designation

Therefore products in this series with minimum CRI value of 80, CCT of 4000K will have the part numbering scheme:

M X C 8 - P W 4 0 - 0 0 0 0

Average Lumen Maintenance Characteristics

Lumen maintenance for solid-state lighting devices (LEDs) is typically defined in terms of the percentage of initial light output remaining after a specified period of time. LM-80 test reports are available upon request.

Environmental Compliance

Lumileds is committed to providing environmentally friendly products to the solid-state lighting market. LUXEON Mid-Power LEDs are compliant to the European Union directives on the restriction of hazardous substances in electronic equipment, namely REACH and the RoHS directive. Lumileds will not intentionally add the following restricted materials to these LEDs: lead, mercury, cadmium, hexavalent chromium, polybrominated biphenyls (PBB) or polybrominated diphenyl ethers (PBDE).

Product Selection

Product Selection for Mid-Power LEDs

Solder Pad Temperature = 25°C, Test Current = 100mA

Table 1.

| Nominal CCT | Part Number | Minimum CRI | Typical CRI | R9 | Min Luminous Flux (lm) ϕ_v | Typ Luminous Flux (lm) ϕ_v |
|-------------|----------------|-------------|-------------|--------|------------------------------------|------------------------------------|
| 2700K | MXC8-PW27-0000 | 80 | 82 | R9>0 | 55 | 80 |
| | MXC9-PW27-1111 | 85 | 90 | R9>50 | 50 | 68 |
| | MXC9-PW27-0000 | 90 | 92 | R9>50 | 50 | 68 |
| 3000K | MXC8-PW30-0000 | 80 | 82 | R9>0 | 55 | 80 |
| | MXC9-PW30-1111 | 85 | 90 | R9>50 | 50 | 68 |
| | MXC9-PW30-0000 | 90 | 92 | R9>50 | 50 | 68 |
| 3500K | MXC8-PW35-0000 | 80 | 82 | R9>0 | 55 | 80 |
| | MXC9-PW35-0000 | 85 | 90 | typ 50 | 50 | 68 |
| 4000K | MXC7-PW40-0000 | 70 | 72 | - | 70 | 77 |
| | MXC8-PW40-0000 | 80 | 82 | R>0 | 60 | 82 |
| | MXC9-PW40-0000 | 85 | 90 | typ 50 | 55 | 65 |
| 5000K | MXC7-PW50-0000 | 70 | 72 | - | 70 | 77 |
| | MXC8-PW50-0000 | 80 | 82 | R>0 | 60 | 83 |
| 5700K | MXC7-PW57-0000 | 70 | 72 | - | 70 | 77 |
| | MXC8-PW57-0000 | 80 | 82 | R>0 | 60 | 73 |
| 6500K | MXC7-PW65-0000 | 70 | 72 | - | 70 | 77 |
| | MXC8-PW65-0000 | 80 | 82 | R9>0 | 60 | 81 |
| | MXC9-PW65-0000 | 86 | 90 | R9>46 | 60 | 76 |

Note for Table 1:

1. Lumileds maintains a tolerance of $\pm 7.5\%$ on luminous flux and ± 2 on CRI measurements.

Optical Characteristics

Optical Characteristics of Mid-Power LEDs

Solder Pad Temperature = 25°C, Test Current = 100mA

Table 2.

| Nominal CCT | Color Temperature CCT | | | Typical Total Included Angle ^[1] (degrees) $\theta_{0.90V}$ | Typical Viewing Angle ^[2] (degrees) $2\theta_{1/2}$ |
|-------------|-----------------------|---------|---------|--|--|
| | Minimum | Typical | Maximum | | |
| 2700K | 2550K | 2700K | 2850K | 150 | 115 |
| 3000K | 2850K | 3000K | 3200K | 150 | 115 |
| 3500K | 3200K | 3500K | 3750K | 150 | 115 |
| 4000K | 3750K | 4000K | 4250K | 150 | 115 |
| 5000K | 4700K | 5000K | 5300K | 150 | 115 |
| 5700K | 5300K | 5700K | 6000K | 150 | 115 |
| 6500K | 6000K | 6500K | 7000K | 150 | 115 |

Notes for Table 2:

1. Total angle at which 90% of total luminous flux is captured.
2. Viewing angle is the off axis angle from lamp centerline where the luminous intensity is 1/2 of the peak value.

Electrical Characteristics

Electrical Characteristics of Mid-Power LEDs

Thermal Pad Temperature = 25°C, Test Current = 100mA

Table 3.

| Part Number | Forward Voltage V_f ^[1] (V) | | | Typical Temperature Coefficient of Forward Voltage ^[2] (mV/°C) $\Delta V_F / \Delta T_J$ | Typical Thermal Resistance Junction to Solder Pad (°C/W) $R\theta_{J-C}$ |
|----------------|--|---------|---------|---|--|
| | Minimum | Typical | Maximum | | |
| MXCx-PWxx-0000 | 5.6 | 6.1 | 6.8 | -2.0 to -4.0 | 18 |

Notes for Table 3:

1. Lumileds maintains a tolerance of $\pm 0.10V$ on forward voltage measurements.
2. Measured at T_J between 25°C and 110°C.

Absolute Maximum Ratings

Table 4.

| Parameter | Maximum Performance |
|--|--|
| DC Forward Current (mA) ^[1] | 200 |
| Peak Pulsed Forward Current (mA) | 240 |
| ESD Sensitivity | Class 2 HBM per ANSI/ESDA/JEDEC JS-001-2012 Pass 400V MM per JEDEC JESD22-A115C |
| LED Junction Temperature ^[2] | 125°C |
| Operating Case Temperature at 100 mA | -40°C - 105°C |
| Storage Temperature | -40°C - 105°C |
| Soldering Temperature | JEDEC 020D 260°C |
| Allowable Reflow Cycles | 3 |
| Reverse Voltage (Vr) ^{[3], [4]} | -5V |

Notes for Table 4:

1. Ripple current with a frequency of 50-150 Hz is allowed, as long as the average of the current waveform is below 200mA, and the maximum of the current waveform is lower than 200mA.
2. Proper current derating must be observed to maintain junction temperature below the maximum.
3. LUXEON Mid-Power LEDs are not designed to be driven in reverse bias.
4. At maximum reverse current of 10µA.

JEDEC Moisture Sensitivity

Table 5.

| Level | Floor Life | | Soak Requirements Standard | |
|-------|------------|--------------------|----------------------------|--------------------|
| | Time | Conditions | Time | Conditions |
| 2 | 1 year | ≤ 30°C / 60% RH | 168 Hrs. + 5 / - 0 Hrs. | ≤ 85°C / 60% RH |

Reflow Soldering Characteristics

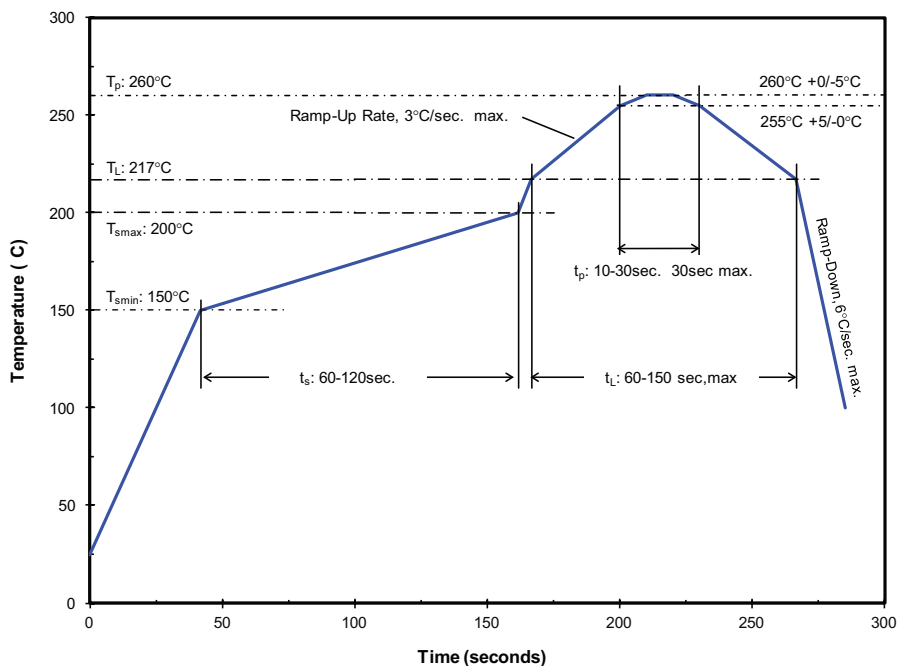

Temperature profile for Table 6.

Table 6. Reflow Profile in Accordance with J-Std-020D.

| Profile Feature | Lead Free Assembly |
|--|--------------------|
| Preheat/Soak : | |
| Temperature Min (T_{smin}) | 150°C |
| Temperature Max (T_{smax}) | 200°C |
| Maximum Time (t_s) from T_{smin} to T_{smax} | 120 seconds |
| Ramp-up Rate (T_L to T_p) | 3°C / second |
| Liquidous Temperature (T_L) | 217°C |
| Maximum Time (t_L) Maintained above T_L | 150 seconds |
| Maximum Peak Package Body Temperature (T_p) | 260°C |
| Time (t_p) within 5°C of the specified temperature (T_c) | 10-30 seconds |
| Maximum Ramp-Down Rate (T_p to T_L) | 6°C / second |
| Maximum Time 25°C to Peak Temperature | 8 minutes |

Note for Table 6:

- All temperatures refer to the application Printed Circuit Board (PCB), measured on the surface adjacent to the package body.

Mechanical Dimensions

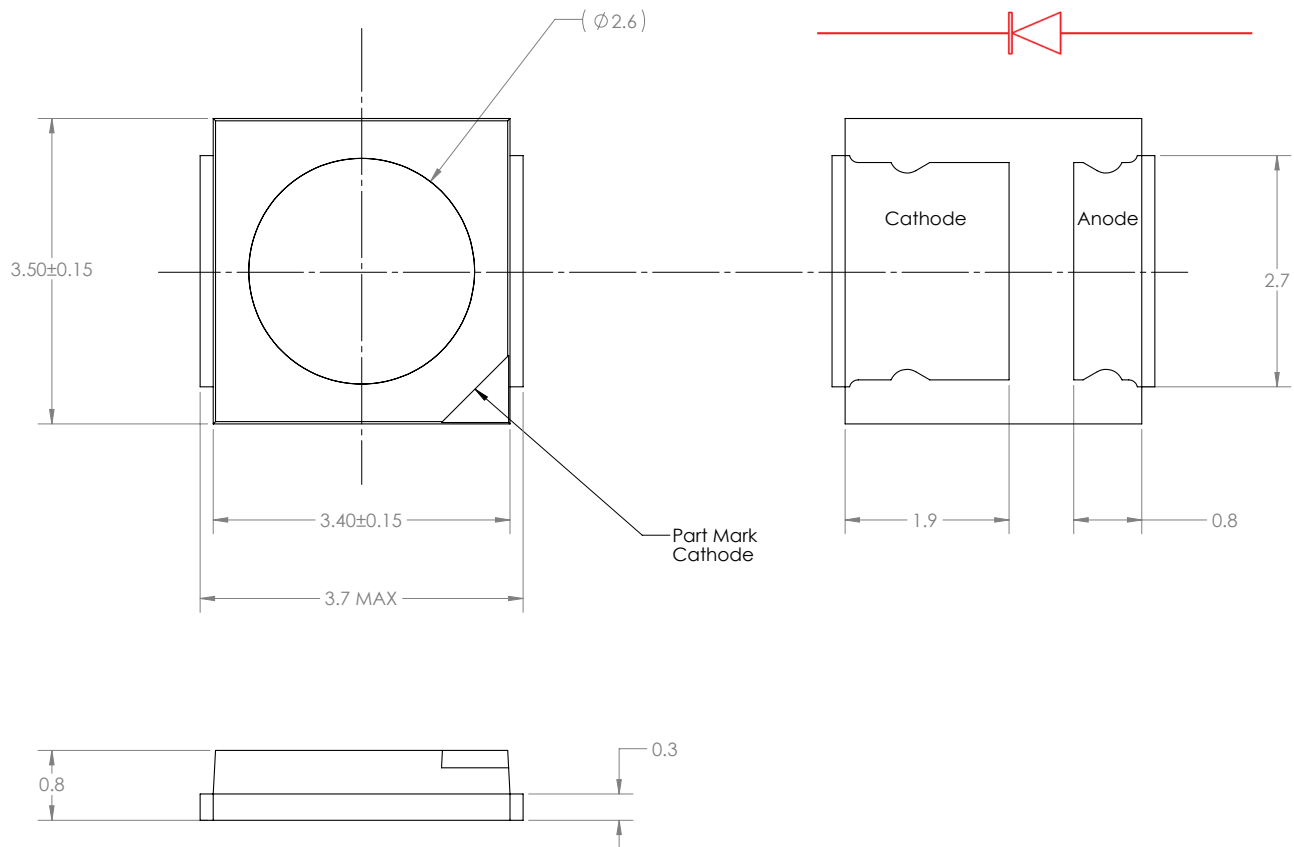

Figure 1. Package outline drawing.

Notes for Figure 1:

1. All dimensions are in millimeters.
2. Tolerance: ± 0.10 mm.
3. Materials
 - Lead Frame: Copper Alloy with Silver Plating
 - Package Body: High Temperature Thermal Plastic
 - Encapsulant: Silicone Resin
 - Solder Lead Finish: Sn-Sn Plating

Solder Pad Design

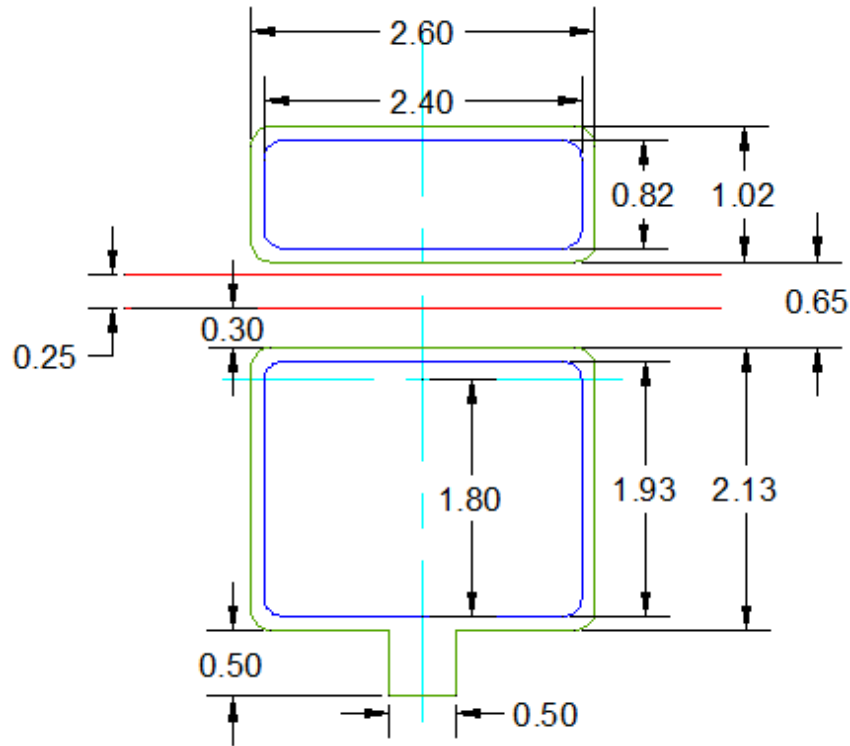

Figure 2. Solder pad layout.

Notes for Figure 2:

1. The drawing above shows the recommended solder pad layout on Printed Circuit Board (PCB).
2. Application Brief AB204 (to be released) provides extensive details for this layout. In addition, the .dwg files are available at www.lumileds.com.

Assembly Precautions

The LUXEON emitter package contains a silicone overcoat to protect the LED chip and extract the maximum amount of light. As with most silicones used in LED optics, care must be taken to prevent any incompatible chemicals from directly or indirectly reacting with the silicone.

The silicone overcoat used in the LUXEON emitter is gas permeable. Consequently, oxygen and volatile organic compound (VOC) gas molecules can diffuse into the silicone overcoat. VOCs may originate from adhesives, solder fluxes, conformal coating materials, potting materials and even some of the inks that are used to print the PCBs.

Some VOCs and chemicals react with silicone and produce discoloration and surface damage. Other VOCs do not chemically react with the silicone material directly but diffuse into the silicone and oxidize during the presence of heat or light. Regardless of the physical mechanism, both cases may affect the total LED light output. Since silicone permeability increases with temperature, more VOCs may diffuse into and/or evaporate out from the silicone.

Please refer to AB203 for more details on VOCs and other incompatible chemicals.

Relative Spectral Distribution

Relative Intensity vs. Wavelength,
MXC7-PWxx

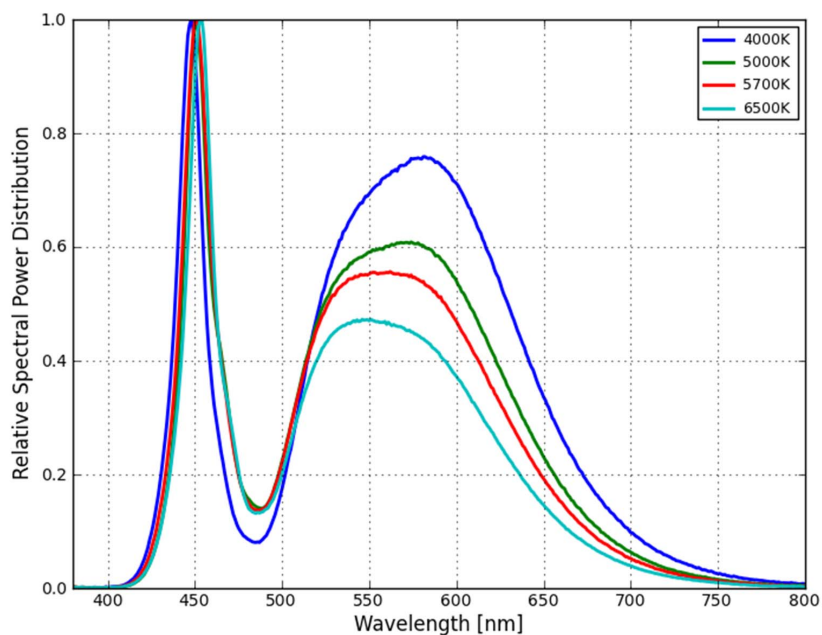

Figure 3a. Typical color spectrum of MXC7-PWxx emitter, integrated measurement at solder pad temperature = 25°C, forward current = 100mA.

Relative Intensity vs. Wavelength,
MXC8-PWxx

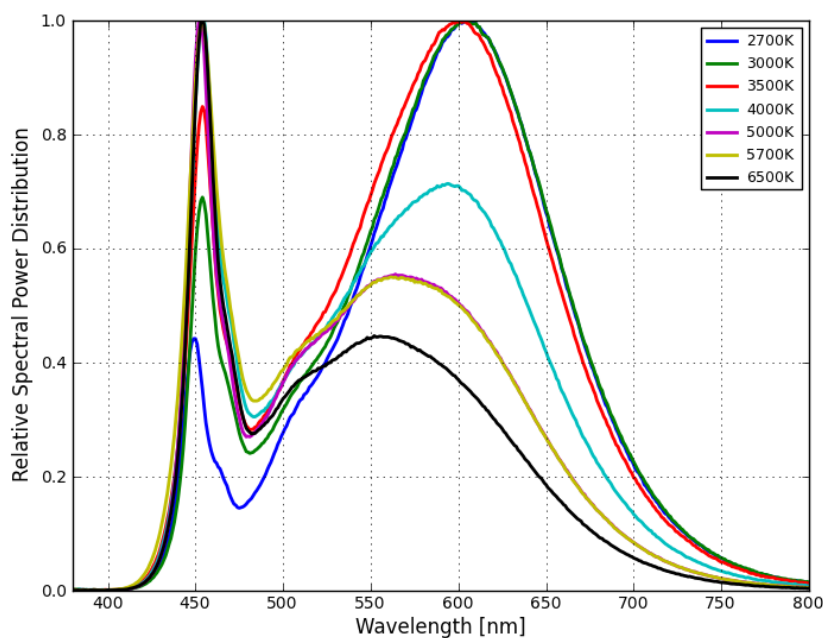

Figure 3b. Typical color spectrum of MXC8-PWxx emitter, integrated measurement at solder pad temperature = 25°C, forward current = 100mA.

Relative Intensity vs. Wavelength, MXC9-PWxx

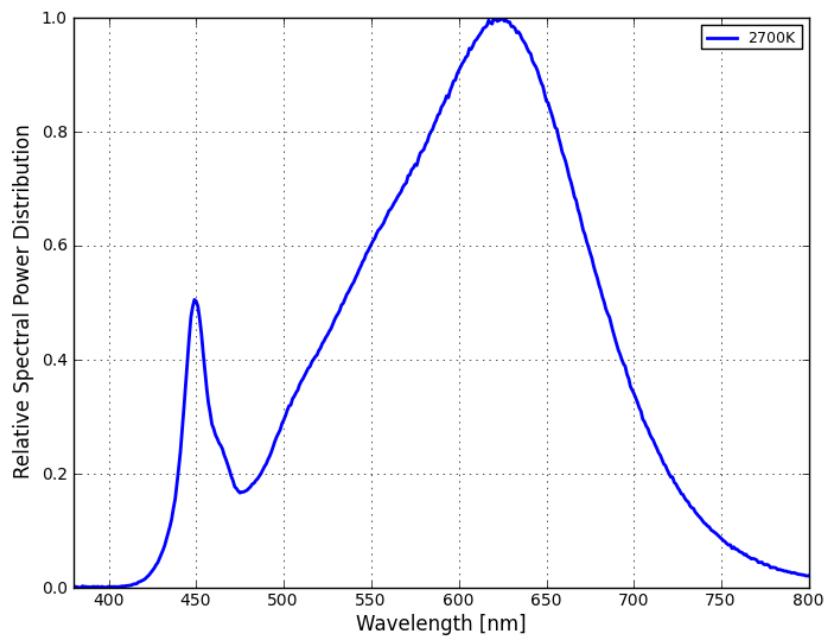

Figure 3c. Typical color spectrum of MXC9-PWxx emitter, integrated measurement at solder pad temperature = 25°C, forward current = 100mA.

Light Output Characteristics

Relative Flux over Temperature MXCx-PWxx

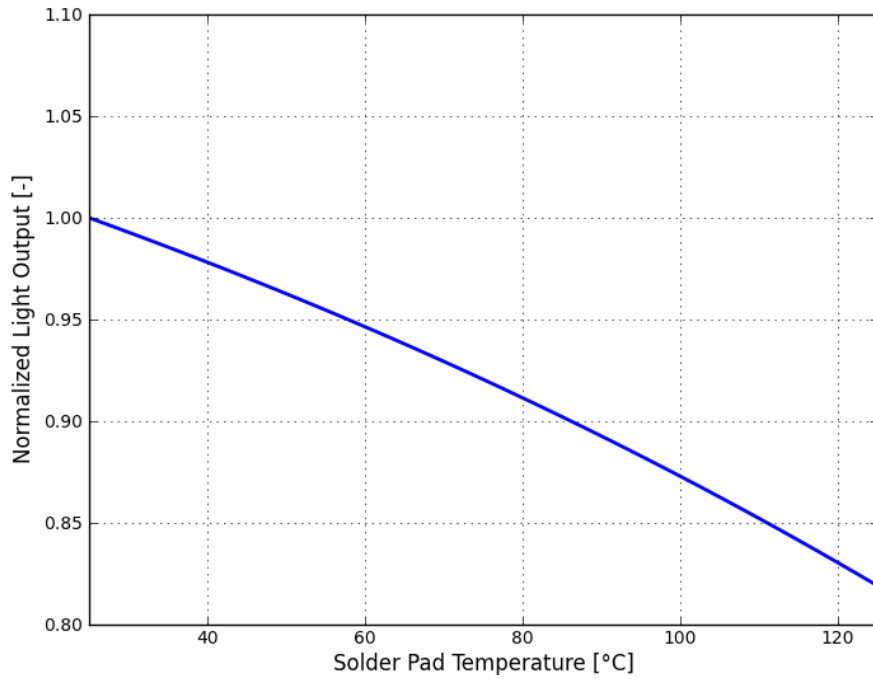

Figure 4. Typical relative light output vs. solder pad temperature, forward current = 100mA.

Relative Flux vs. Forward Current MXCx-PWxx

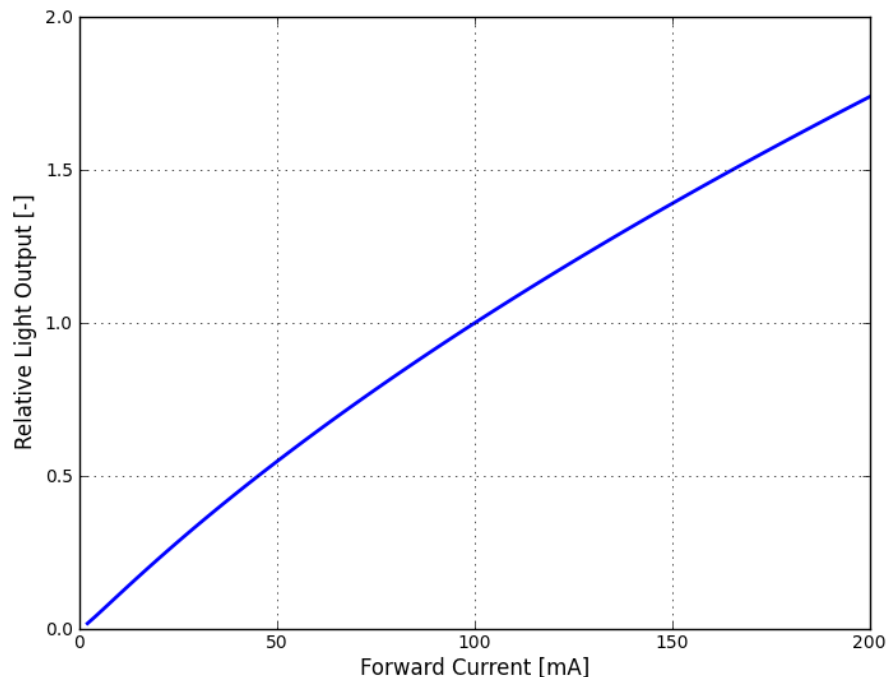

Figure 5. Typical relative luminous flux vs. forward current, solder pad temperature = 25°C.

Luminous Efficacy Characteristics

Relative Luminous Efficacy vs. Forward Current
MXCx-PWxx

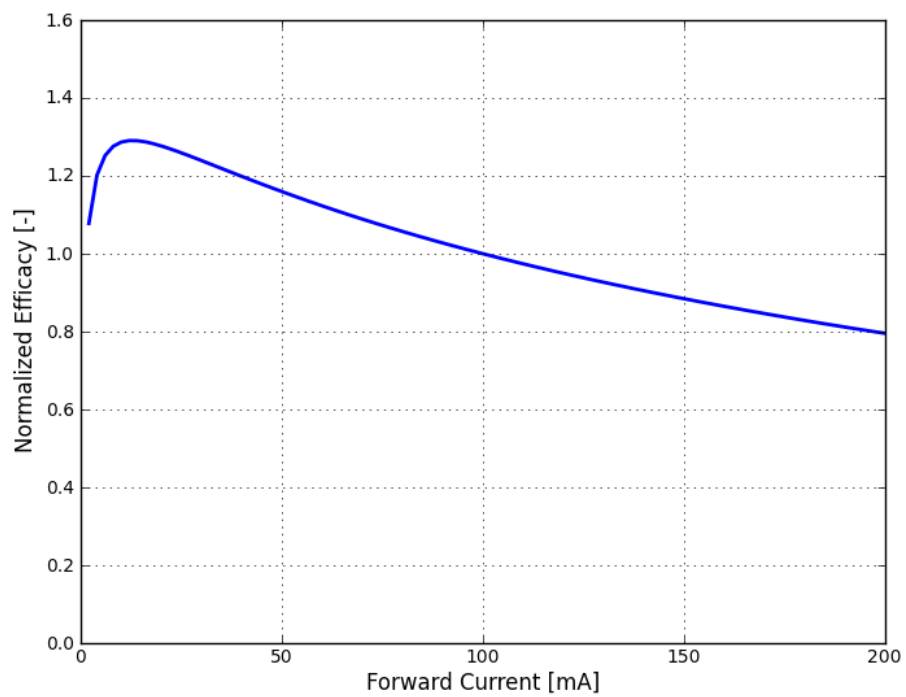

Figure 6. Typical emitter efficacy versus forward current, solder pad temperature = 25°C.

Forward Current Characteristics

Forward Current vs. Forward Voltage MXCx-PWxx

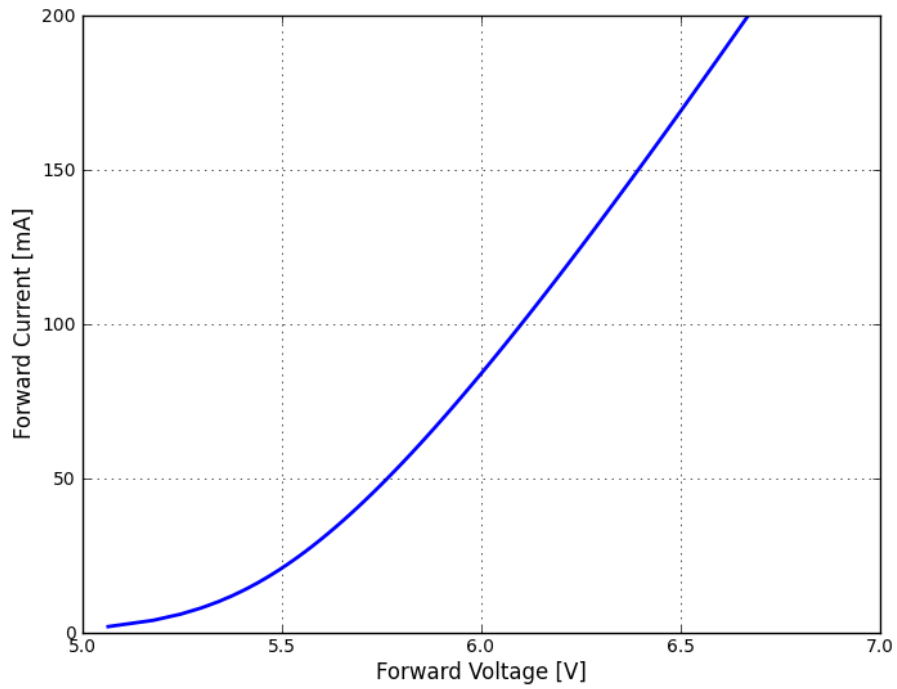

Figure 7. Typical forward current vs. forward voltage, solder pad temperature = 25°C.

Typical Radiation Patterns

Radiation Pattern in Cartesian Coordinate System

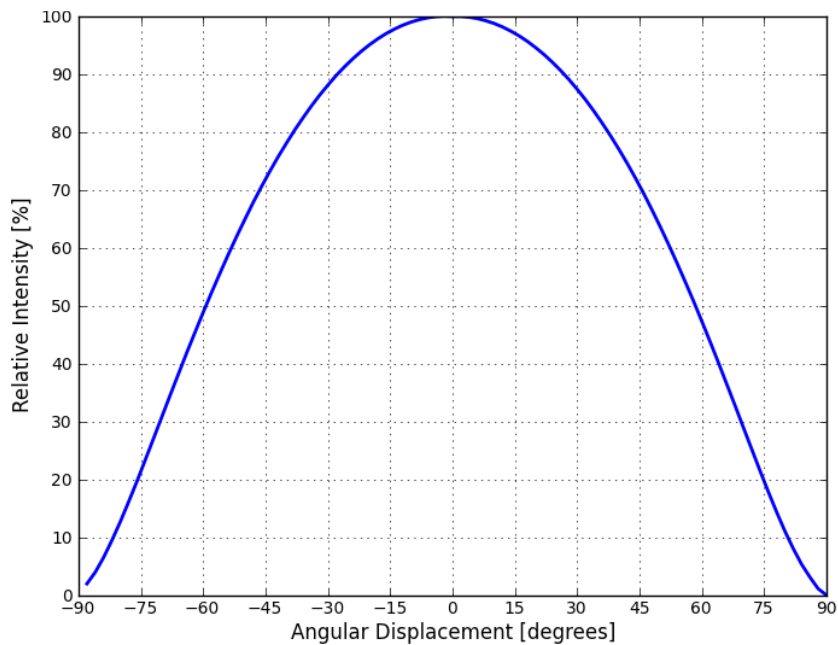

Figure 8. Typical representative spatial radiation pattern.

Radiation Pattern in Polar Coordinate System

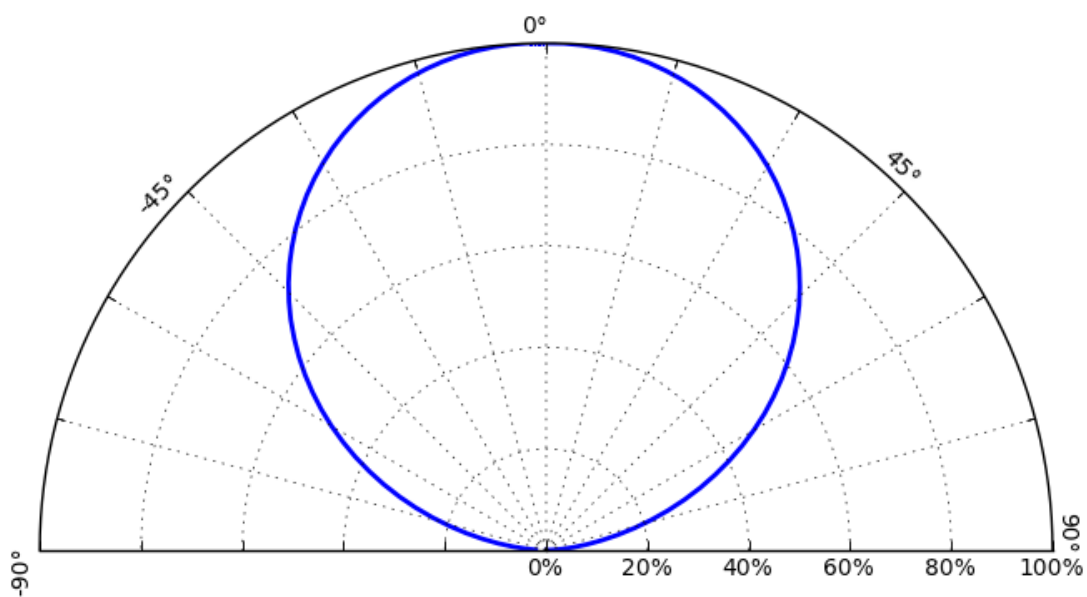

Figure 9. Typical polar plot of radiation pattern.

Emitter Pocket Tape Packaging

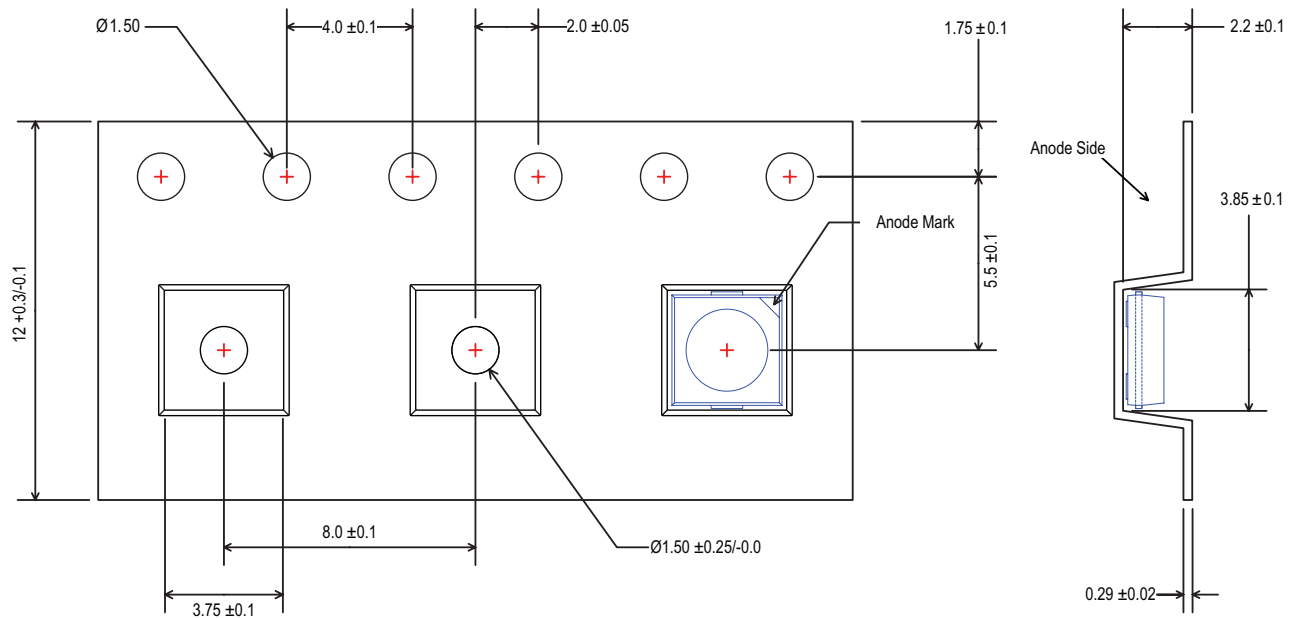

Figure 10. Emitter pocket tape packaging.

Notes for Figure 10:

1. All dimensions are in millimeters
2. Empty component pockets sealed with top cover tape
3. The maximum number of consecutive missing LEDs is two.

Emitter Reel Packaging

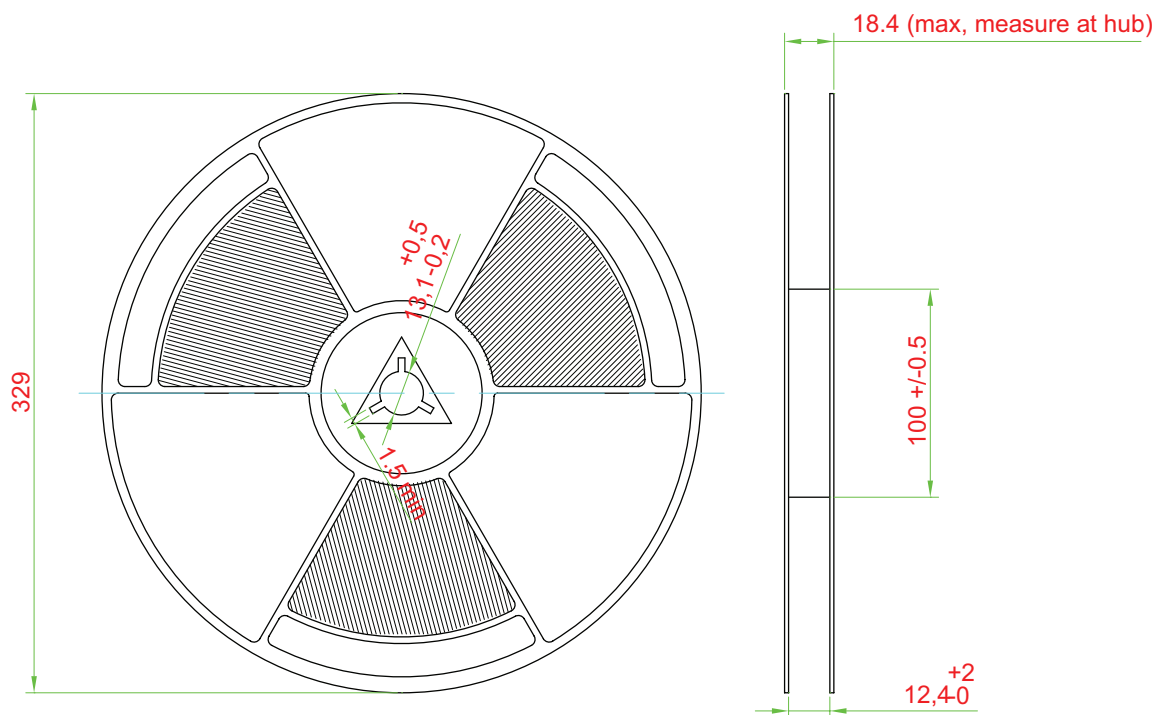

Figure 11. Emitter reel packaging.

Notes for Figure 11:

- All dimensions are in millimeters.
- Empty component pockets sealed with top cover tape.
- 329 mm reel - 5000 pieces per reel.
- Minimum packing quantity is 5000 pieces.
- The maximum number of consecutive missing LEDs is two.
- In accordance with EIA-481-1-B specification.

Product Binning and Labeling

Purpose of Product Binning

In the manufacturing of semiconductor products, there is a variation of performance around the average values given in the technical data sheets. For this reason, Lumileds bins the LED components for luminous flux, color and forward voltage (V_f).

Decoding Product Bin Labeling

LUXEON Mid-Power emitters are labeled using a four digit alphanumeric code (CAT code) depicting the bin values for emitters packaged on a single reel. All emitters packaged within a reel are of the same 3-variable bin combination. Using these codes, it is possible to determine optimum mixing and matching of products for consistency in a given application.

Reels of 2700K, 3000K, 3500K, 4000K, 5000K, 5700K and 6500K emitters are labeled with a four or five digit alphanumeric CAT code following the format below.

A B C D or A x B C D

Where:

A = Flux bin (D, etc.)

x = Lumileds internal use

B and C = Color bin (For example 51, 52, 53, 54, 55, 56 or 5D, 5E, 8F, 8G, 8H, 8J, 8K, 8L, 8M)

D = V_f bin

Luminous Flux Bins

Table 7 lists the standard photometric luminous flux bins for LUXEON Mid-Power emitters (tested and binned at 100mA).

Although several bins are outlined, product availability in a particular bin varies by production run and by product performance.

Not all bins are available in all colors.

Table 7. Flux Bins

| Bin Code | Minimum Photometric Flux (lm) | Maximum Photometric Flux (lm) |
|----------|-------------------------------|-------------------------------|
| A | 55 | 60 |
| B | 60 | 65 |
| C | 65 | 70 |
| D | 70 | 75 |
| E | 75 | 80 |
| F | 80 | 85 |
| G | 85 | 90 |
| H | 90 | 95 |
| J | 95 | 100 |
| K | 100 | 105 |
| L | 105 | 110 |
| M | 110 | 115 |
| N | 115 | 120 |

Tested and binned at 25°C, $I_f=100\text{mA}$. Tester tolerance: $\pm 7.5\%$.

Forward Voltage Bins

Table 8. V_f Bins

| Bin Code | Minimum Forward Voltage (V) | Maximum Forward Voltage (V) |
|----------|-----------------------------|-----------------------------|
| F | 5.6 | 5.8 |
| G | 5.8 | 6 |
| H | 6 | 6.2 |
| J | 6.2 | 6.4 |
| K | 6.4 | 6.6 |
| L | 6.6 | 6.8 |

Tested and binned at 25°C, $I_f = 100\text{mA}$. Tester tolerance: $\pm 0.10\text{V}$.

Color Bin Structure

MXCx-PW27-xxxx 1/6th Color Bin Structure

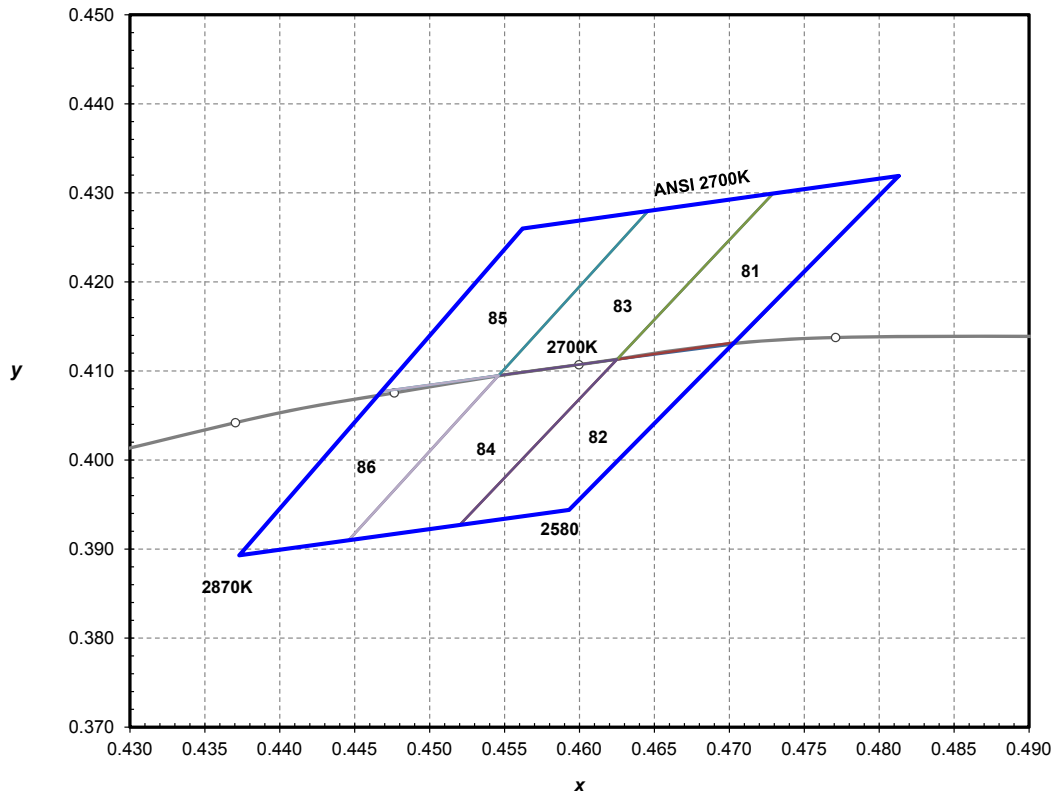

Figure 12. ANSI 2700K 1/6th color bin structure.

LUXEON Mid-Power Emitters are tested and binned by x,y coordinates.

Table 9.

| LUXEON Mid-Power ANSI 1/6 Color Bin Coordinates for MXCx-PW27-xxxx Emitter | | | | | |
|--|--------|--------|----------|--------|--------|
| Bin Code | x | y | Bin Code | x | y |
| 81 | 0.4625 | 0.4113 | 84 | 0.4446 | 0.3910 |
| | 0.4729 | 0.4299 | | 0.4546 | 0.4095 |
| | 0.4813 | 0.4319 | | 0.4625 | 0.4113 |
| | 0.4703 | 0.4132 | | 0.4520 | 0.3927 |
| 82 | 0.4520 | 0.3927 | 85 | 0.4468 | 0.4077 |
| | 0.4625 | 0.4113 | | 0.4562 | 0.4260 |
| | 0.4703 | 0.4132 | | 0.4646 | 0.4280 |
| | 0.4593 | 0.3944 | | 0.4546 | 0.4095 |
| 83 | 0.4546 | 0.4095 | 86 | 0.4373 | 0.3893 |
| | 0.4646 | 0.4280 | | 0.4468 | 0.4077 |
| | 0.4729 | 0.4299 | | 0.4546 | 0.4095 |
| | 0.4625 | 0.4113 | | 0.4446 | 0.3910 |

Notes for Table 9:

1. Tested and binned at 25°C and If = 100 mA. Tester tolerance: +/- 0.01 in x and y coordinates

Color Bin Structure, Continued

MXCx-PW27-xxxx 1/9th Color Bin Structure

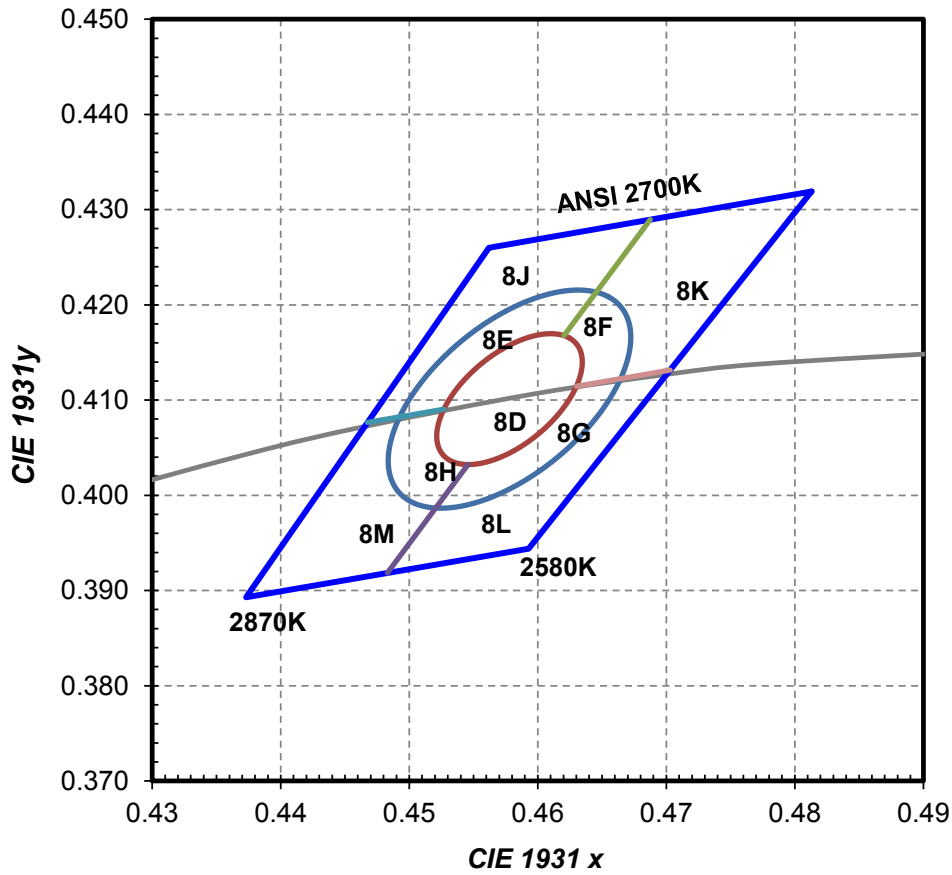

Figure 13. ANSI 2700K 1/9th color bin structure.

LUXEON Mid-Power Emitters are tested and binned by x,y coordinates.

Table 10.

| Nominal ANSI CCT | Color Space | Target Center Point (cx, cy) | Major Axis, a | Minor Axis, b | Ellipse Rotation Angle |
|------------------|-------------------------------|------------------------------|---------------|---------------|------------------------|
| 2700K | Single 3-step MacAdam ellipse | (0.4578, 0.4101) | 0.00810 | 0.00420 | 53.70° |
| 2700K | Single 5-step MacAdam ellipse | (0.4578, 0.4101) | 0.01350 | 0.00700 | 53.70° |

Notes for Table 10:

1. Tested and binned at 25°C and If = 100mA. Tester tolerance: +/- 0.01 in x and y coordinates.

Color Bin Structure, Continued

MXCx-PW30-xxxxx 1/6th Color Bin Structure

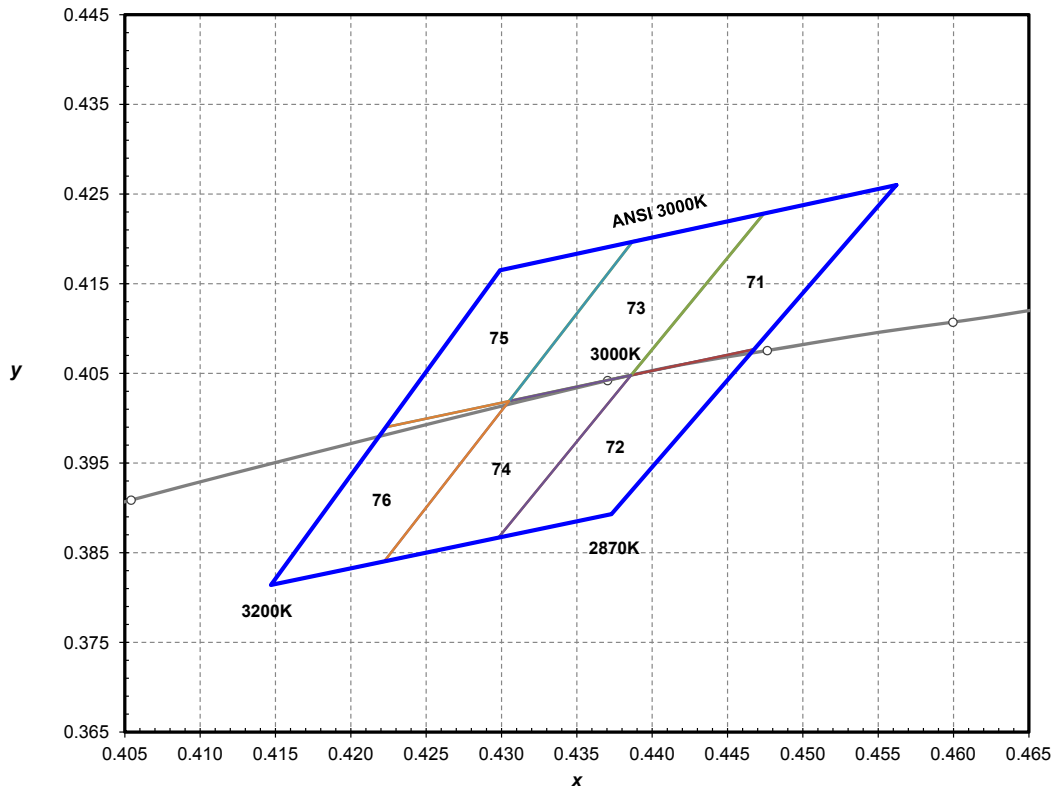

Figure 14. ANSI 3000K 1/6th color bin structure.

LUXEON Mid-Power Emitters are tested and binned by x,y coordinates.

Table 11.

| LUXEON Mid-Power ANSI 1/6 Color Bin Coordinates for MXCx-PW30-xxxx Emitter | | | | | |
|--|--------|--------|----------|--------|--------|
| Bin Code | x | y | Bin Code | x | y |
| 71 | 0.4386 | 0.4048 | 74 | 0.4222 | 0.3840 |
| | 0.4474 | 0.4228 | | 0.4305 | 0.4019 |
| | 0.4562 | 0.4260 | | 0.4386 | 0.4048 |
| | 0.4468 | 0.4077 | | 0.4298 | 0.3867 |
| 72 | 0.4298 | 0.3867 | 75 | 0.4223 | 0.3990 |
| | 0.4386 | 0.4048 | | 0.4299 | 0.4165 |
| | 0.4468 | 0.4077 | | 0.4387 | 0.4197 |
| | 0.4373 | 0.3893 | | 0.4305 | 0.4019 |
| 73 | 0.4305 | 0.4019 | 76 | 0.4147 | 0.3814 |
| | 0.4387 | 0.4197 | | 0.4223 | 0.3990 |
| | 0.4474 | 0.4228 | | 0.4305 | 0.4019 |
| | 0.4386 | 0.4048 | | 0.4222 | 0.3840 |

Notes for Table 11:

1. Tested and binned at 25°C and If = 100 mA. Tester tolerance: +/- 0.01 in x and y coordinates

Color Bin Structure, Continued

MXCx-PW30-xxxxx 1/9th Color Bin Structure

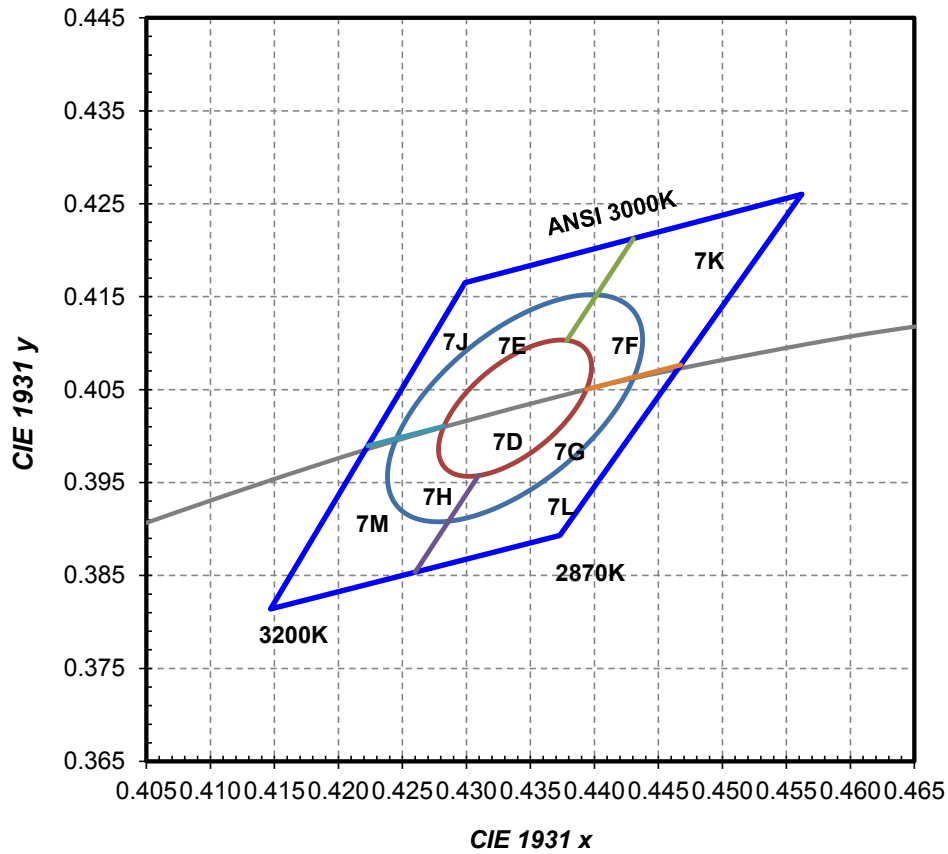

Figure 15. ANSI 3000K 1/9th color bin structure.

LUXEON Mid-Power Emitters are tested and binned by x,y coordinates.

Table 12.

| Nominal ANSI CCT | Color Space | Target Center Point (cx, cy) | Major Axis, a | Minor Axis, b | Ellipse Rotation Angle |
|------------------|-------------------------------|------------------------------|---------------|---------------|------------------------|
| 3000K | Single 3-step MacAdam ellipse | (0.4338, 0.403) | 0.00834 | 0.00408 | 53.22° |
| 3000K | Single 5-step MacAdam ellipse | (0.4338, 0.403) | 0.01390 | 0.00680 | 53.22° |

Notes for Table 12:

1. Tested and binned at 25°C and If = 100mA. Tester tolerance: +/- 0.01 in x and y coordinates.

Color Bin Structure, Continued

MXCx-PW35-xxxx 1/6th Color Bin Structure

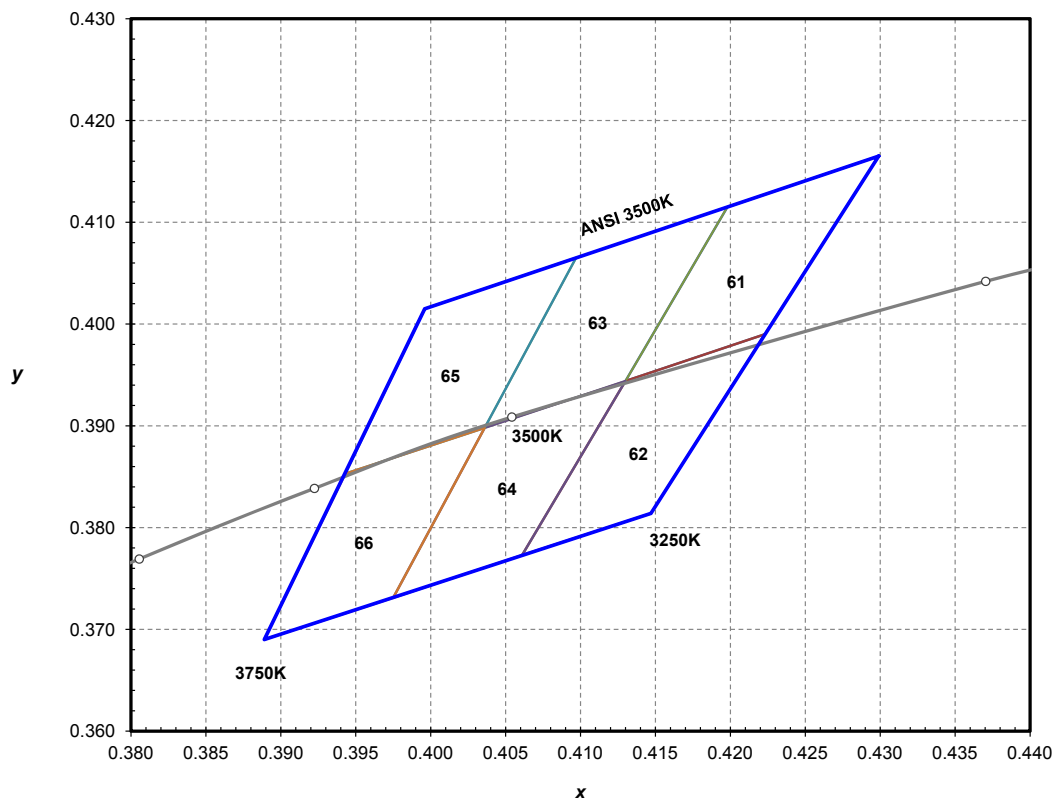

Figure 16. ANSI 3500K 1/6th color bin structure.

LUXEON Mid-Power Emitters are tested and binned by x,y coordinates.

Table 13.

| LUXEON Mid-Power ANSI 1/6 Color Bin Coordinates for MXCx-PW35-xxxx Emitter | | | | | |
|--|--------|--------|----------|--------|--------|
| Bin Code | x | y | Bin Code | x | y |
| 61 | 0.4130 | 0.3944 | 64 | 0.3975 | 0.3731 |
| | 0.4198 | 0.4115 | | 0.4036 | 0.3898 |
| | 0.4299 | 0.4165 | | 0.4130 | 0.3944 |
| | 0.4223 | 0.3990 | | 0.4061 | 0.3773 |
| 62 | 0.4061 | 0.3773 | 65 | 0.3943 | 0.3853 |
| | 0.4130 | 0.3944 | | 0.3996 | 0.4015 |
| | 0.4223 | 0.3990 | | 0.4097 | 0.4065 |
| | 0.4147 | 0.3814 | | 0.4036 | 0.3898 |
| 63 | 0.4036 | 0.3898 | 66 | 0.3889 | 0.3690 |
| | 0.4097 | 0.4065 | | 0.3943 | 0.3853 |
| | 0.4198 | 0.4115 | | 0.4036 | 0.3898 |
| | 0.4130 | 0.3944 | | 0.3975 | 0.3731 |

Notes for Table 13:

1. Tested and binned at 25°C and If = 100 mA. Tester tolerance: +/- 0.01 in x and y coordinates

Color Bin Structure, Continued

MXCx-PW35-xxxxx 1/9th Color Bin Structure

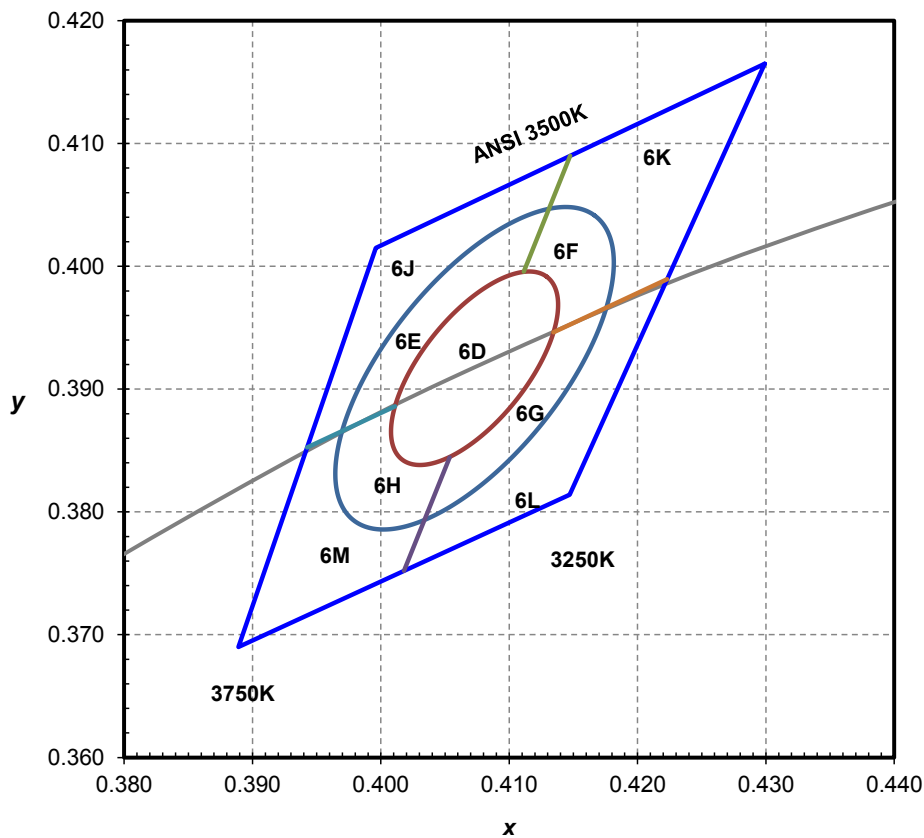

Figure 17. ANSI 3500K 1/9th color bin structure.

LUXEON Mid-Power Emitters are tested and binned by x,y coordinates.

Table 14.

| Nominal ANSI CCT | Color Space | Target Center Point (cx, cy) | Major Axis, a | Minor Axis, b | Ellipse Rotation Angle |
|------------------|-------------------------------|------------------------------|---------------|---------------|------------------------|
| 3500K | Single 3-step MacAdam ellipse | (0.4073, 0.3917) | 0.00927 | 0.00414 | 53.22° |
| 3500K | Single 5-step MacAdam ellipse | (0.4073, 0.3917) | 0.01545 | 0.00690 | 53.22° |

Notes for Table 14:

1. Tested and binned at 25°C and If = 100mA. Tester tolerance: +/- 0.01 in x and y coordinates.

Color Bin Structure, Continued

MXCx-PW40-xxxx 1/6th Color Bin Structure

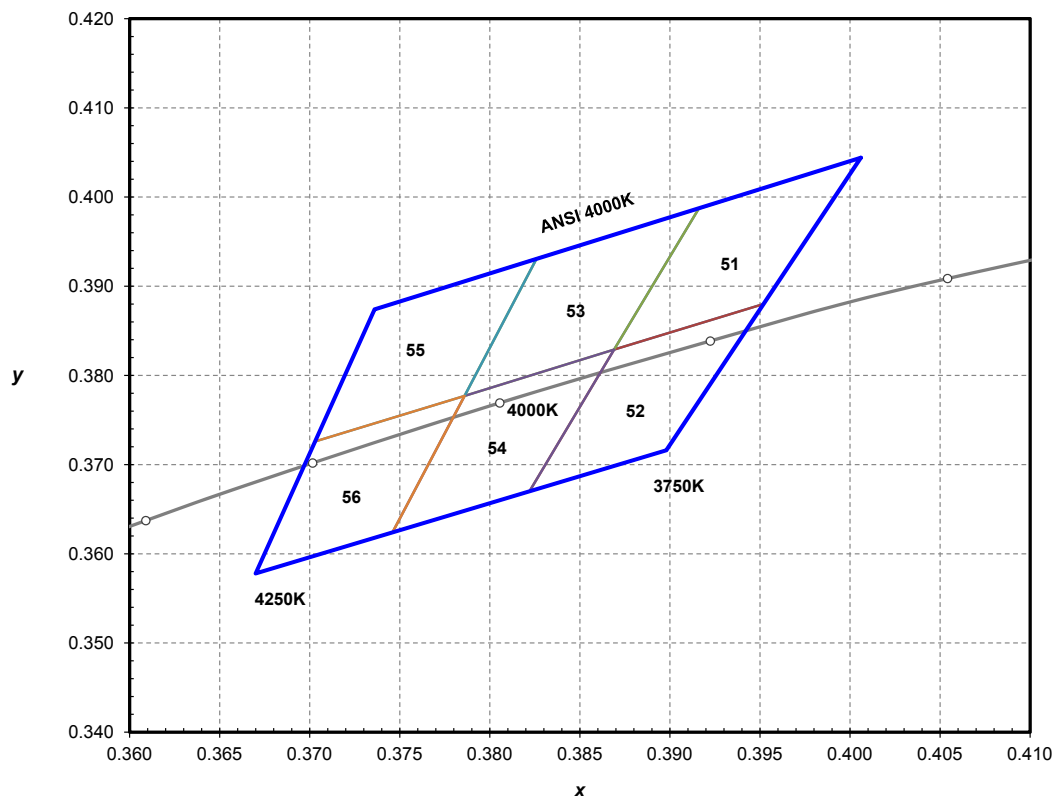

Figure 18. ANSI 4000K 1/6th color bin structure.

LUXEON Mid-Power Emitters are tested and binned by x,y coordinates.

Table 15.

| LUXEON Mid-Power ANSI 1/6 Color Bin Coordinates for MXCx-PW40-xxxxx Emitter | | | | | |
|---|--------|--------|----------|--------|--------|
| Bin Code | x | y | Bin Code | x | y |
| 51 | 0.3869 | 0.3829 | 54 | 0.3746 | 0.3624 |
| | 0.3916 | 0.3987 | | 0.3786 | 0.3777 |
| | 0.4006 | 0.4044 | | 0.3869 | 0.3829 |
| | 0.3952 | 0.3880 | | 0.3822 | 0.3670 |
| 52 | 0.3822 | 0.3670 | 55 | 0.3703 | 0.3726 |
| | 0.3869 | 0.3829 | | 0.3736 | 0.3874 |
| | 0.3952 | 0.3880 | | 0.3826 | 0.3931 |
| | 0.3898 | 0.3716 | | 0.3786 | 0.3777 |
| 53 | 0.3786 | 0.3777 | 56 | 0.3670 | 0.3578 |
| | 0.3826 | 0.3931 | | 0.3703 | 0.3726 |
| | 0.3916 | 0.3987 | | 0.3786 | 0.3777 |
| | 0.3869 | 0.3829 | | 0.3746 | 0.3624 |

Notes for Table 15:

1. Tested and binned at 25°C and If = 100 mA. Tester tolerance: +/- 0.01 in x and y coordinates

Color Bin Structure, Continued

MXCx-PW40-xxxx 1/9th Color Bin Structure

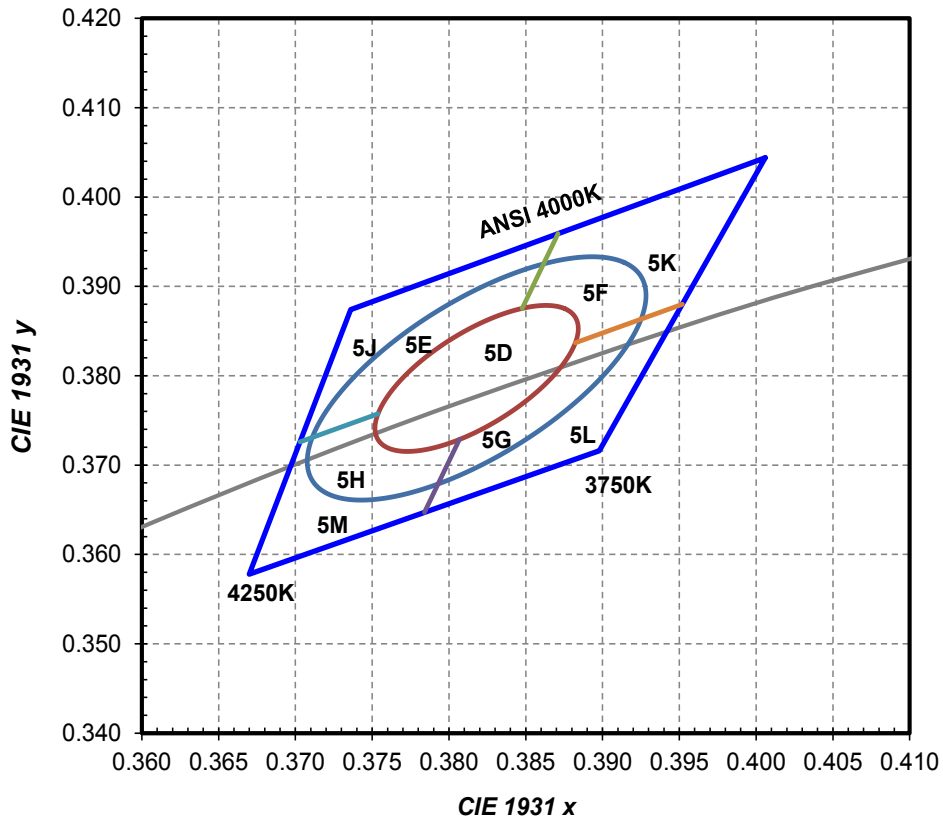

Figure 19. ANSI 4000K 1/9th color bin structure.

LUXEON Mid-Power Emitters are tested and binned by x,y coordinates.

Table 16.

| Nominal ANSI CCT | Color Space | Target Center Point (cx, cy) | Major Axis, a | Minor Axis, b | Ellipse Rotation Angle |
|------------------|-------------------------------|------------------------------|---------------|---------------|------------------------|
| 4000K | Single 3-step MacAdam ellipse | (0.3818, 0.3797) | 0.00939 | 0.00402 | 53.72° |
| 4000K | Single 5-step MacAdam ellipse | (0.3818, 0.3797) | 0.01565 | 0.00670 | 53.72° |

Notes for Table 16:

1. Tested and binned at 25°C and If = 100mA. Tester tolerance: +/- 0.01 in x and y coordinates.

Color Bin Structure, Continued

MXCx-PW50-xxxx 1/6th Color Bin Structure

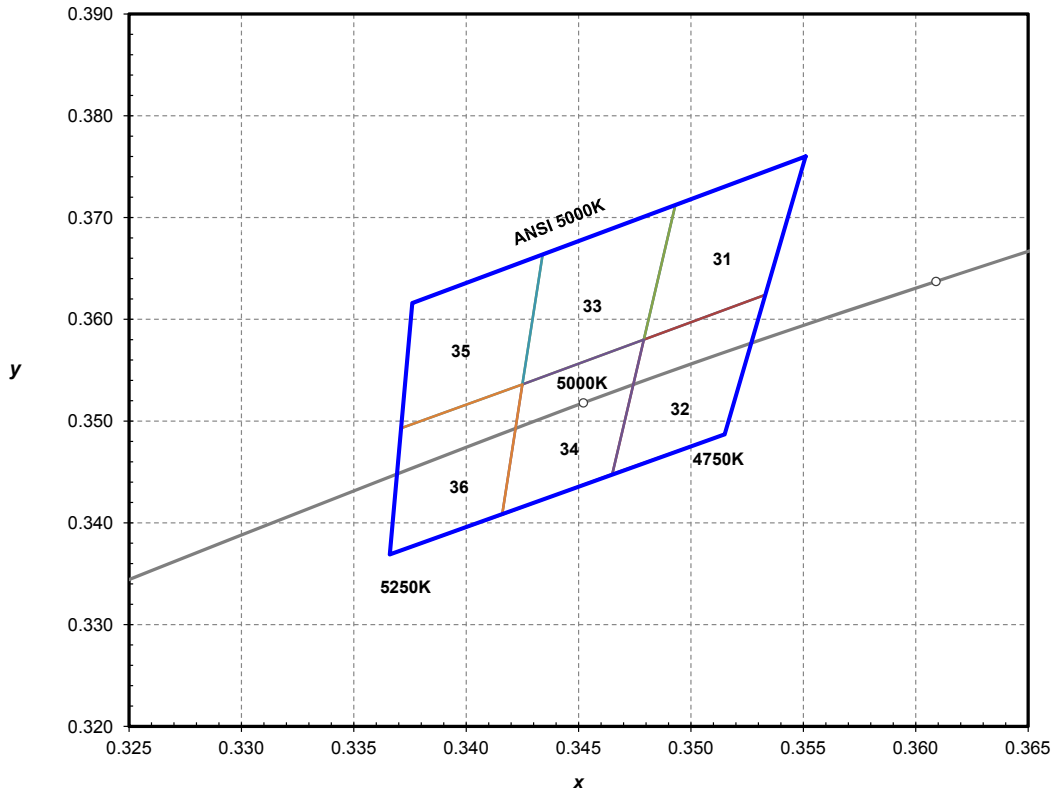

Figure 20. ANSI 5000K 1/6th color bin structure.

LUXEON Mid-Power Emitters are tested and binned by x,y coordinates.

Table 17.

| LUXEON Mid-Power ANSI 1/6 Color Bin Coordinates for MXCx-PW50-xxxx Emitter | | | | | |
|--|--------|--------|----------|--------|--------|
| Bin Code | x | y | Bin Code | x | y |
| 31 | 0.3479 | 0.3580 | 34 | 0.3416 | 0.3408 |
| | 0.3493 | 0.3712 | | 0.3425 | 0.3536 |
| | 0.3551 | 0.3760 | | 0.3479 | 0.3580 |
| | 0.3533 | 0.3624 | | 0.3465 | 0.3448 |
| 32 | 0.3465 | 0.3448 | 35 | 0.3371 | 0.3493 |
| | 0.3479 | 0.3580 | | 0.3376 | 0.3616 |
| | 0.3533 | 0.3624 | | 0.3434 | 0.3664 |
| | 0.3515 | 0.3487 | | 0.3425 | 0.3536 |
| 33 | 0.3425 | 0.3536 | 36 | 0.3366 | 0.3369 |
| | 0.3434 | 0.3664 | | 0.3371 | 0.3493 |
| | 0.3493 | 0.3712 | | 0.3425 | 0.3536 |
| | 0.3479 | 0.3580 | | 0.3416 | 0.3408 |

Notes for Table 17:

1. Tested and binned at 25°C and If = 100 mA. Tester tolerance: +/- 0.01 in x and y coordinates

Color Bin Structure, Continued

MXCx-PW50-xxxx 1/9th Color Bin Structure

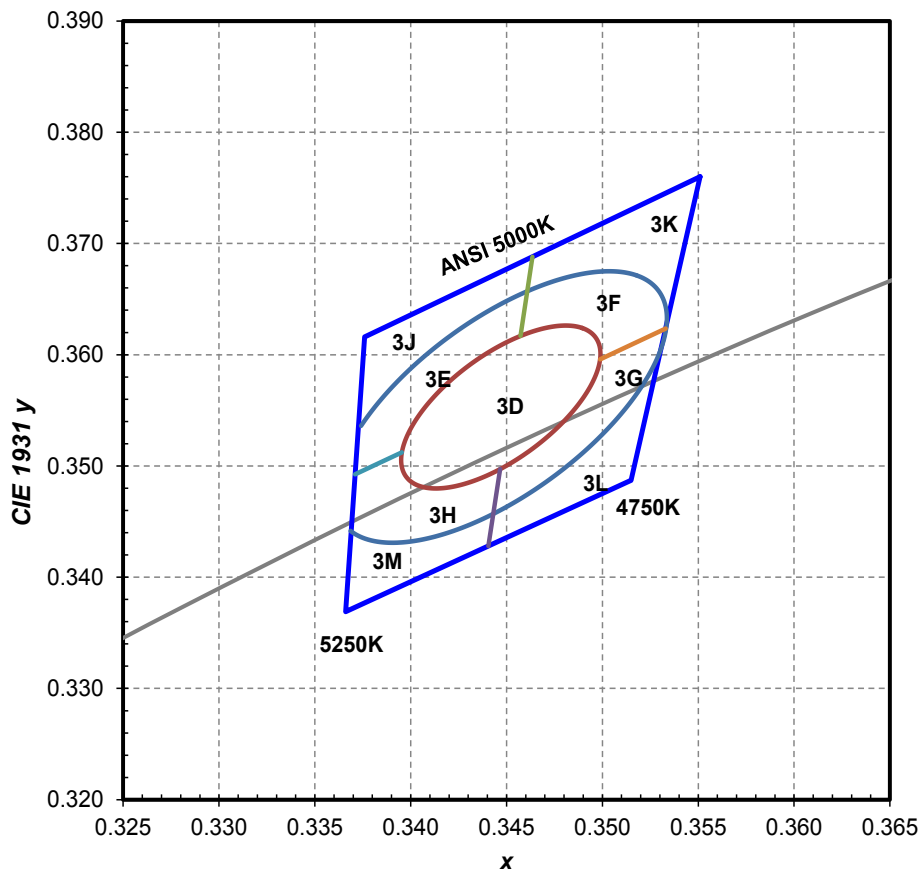

Figure 21. ANSI 5000K 1/9th color bin structure.

LUXEON Mid-Power Emitters are tested and binned by x,y coordinates.

Table 18.

| Nominal ANSI CCT | Color Space | Target Center Point (cx, cy) | Major Axis, a | Minor Axis, b | Ellipse Rotation Angle |
|------------------|-------------------------------|------------------------------|---------------|---------------|------------------------|
| 5000K | Single 3-step MacAdam ellipse | (0.3447, 0.3553) | 0.00822 | 0.00354 | 59.62° |
| 5000K | Single 5-step MacAdam ellipse | (0.3447, 0.3553) | 0.01370 | 0.00590 | 59.62° |

Notes for Table 18:

1. Tested and binned at 25°C and If = 100mA. Tester tolerance: +/- 0.01 in x and y coordinates.

Color Bin Structure, Continued

MXCx-PW57-xxxxx 1/6th Color Bin Structure

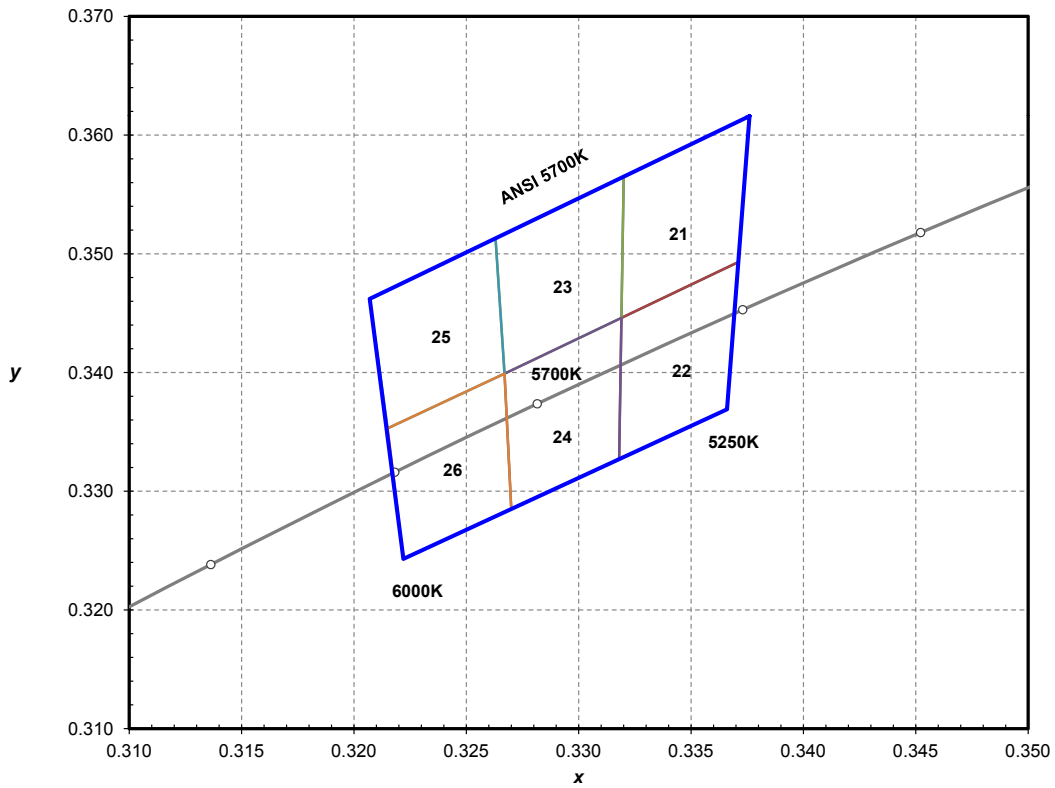

Figure 22. ANSI 5700K 1/6th color bin structure.

LUXEON Mid-Power Emitters are tested and binned by x,y coordinates.

Table 19.

| LUXEON Mid-Power ANSI 1/6 Color Bin Coordinates for MXCx-PW57-xxxxx Emitter | | | | | |
|---|--------|--------|----------|--------|--------|
| Bin Code | x | y | Bin Code | x | y |
| 21 | 0.3319 | 0.3446 | 24 | 0.3270 | 0.3285 |
| | 0.3320 | 0.3565 | | 0.3267 | 0.3399 |
| | 0.3376 | 0.3616 | | 0.3319 | 0.3446 |
| | 0.3371 | 0.3493 | | 0.3318 | 0.3327 |
| 22 | 0.3318 | 0.3327 | 25 | 0.3215 | 0.3353 |
| | 0.3319 | 0.3446 | | 0.3207 | 0.3462 |
| | 0.3371 | 0.3493 | | 0.3263 | 0.3513 |
| | 0.3366 | 0.3369 | | 0.3267 | 0.3399 |
| 23 | 0.3267 | 0.3399 | 26 | 0.3222 | 0.3243 |
| | 0.3263 | 0.3513 | | 0.3215 | 0.3353 |
| | 0.3320 | 0.3565 | | 0.3267 | 0.3399 |
| | 0.3319 | 0.3446 | | 0.3270 | 0.3285 |

Notes for Table 19:

1. Tested and binned at 25°C and If = 100 mA. Tester tolerance: +/- 0.01 in x and y coordinates

Color Bin Structure, Continued

MXCx-PW57-xxxxx 1/9th Color Bin Structure

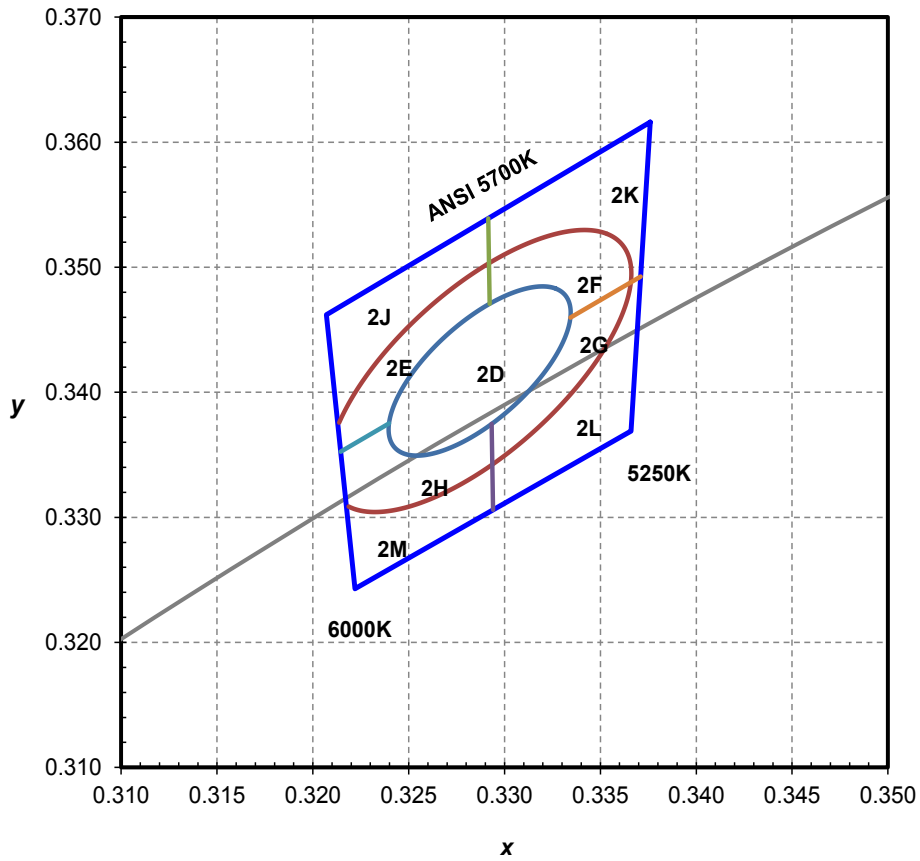

Figure 23. ANSI 5700K 1/9th color bin structure.

LUXEON Mid-Power Emitters are tested and binned by x,y coordinates.

Table 20.

| Nominal ANSI CCT | Color Space | Target Center Point (cx, cy) | Major Axis, a | Minor Axis, b | Ellipse Rotation Angle |
|------------------|-------------------------------|------------------------------|---------------|---------------|------------------------|
| 5700K | Single 3-step MacAdam ellipse | (0.3287, 0.3417) | 0.00746 | 0.00320 | 59.09° |
| 5700K | Single 5-step MacAdam ellipse | (0.3287, 0.3417) | 0.01243 | 0.00533 | 59.09° |

Notes for Table 20:

1. Tested and binned at 25°C and If = 100mA. Tester tolerance: +/- 0.01 in x and y coordinates.

Color Bin Structure, Continued

MXCx-PW65-xxxxx 1/6th Color Bin Structure

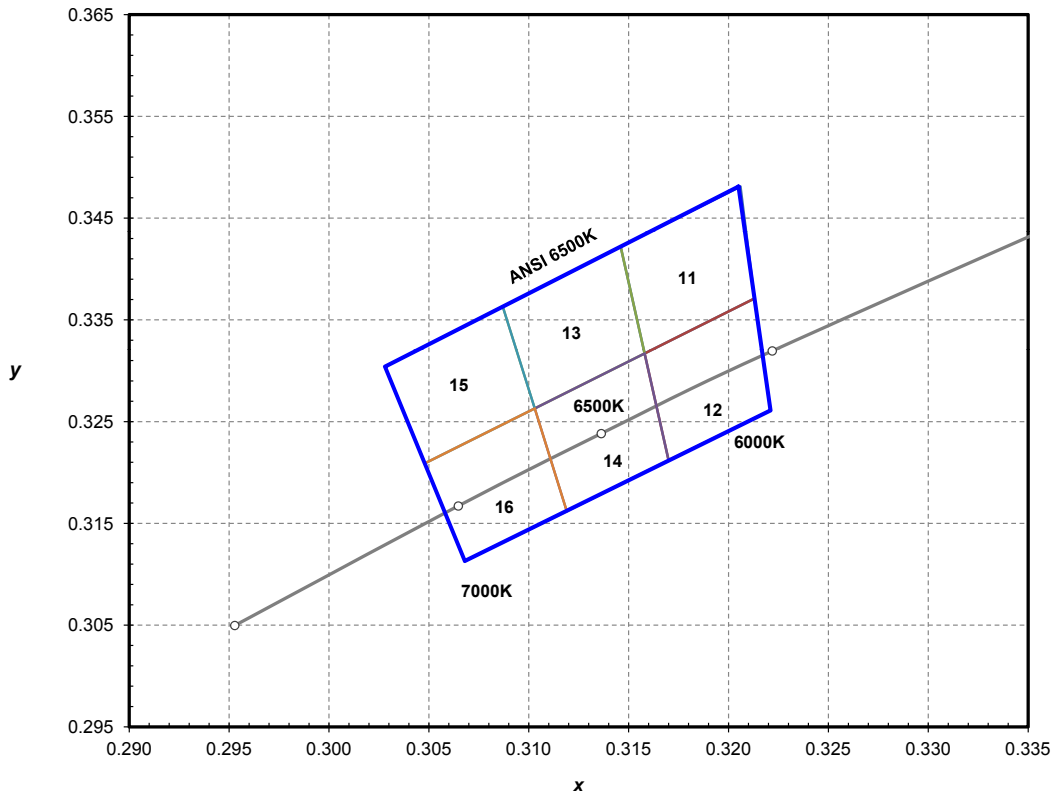

Figure 24. ANSI 6500K 1/6th color bin structure.

LUXEON Mid-Power Emitters are tested and binned by x,y coordinates.

Table 21.

| LUXEON Mid-Power ANSI 1/6 Color Bin Coordinates for MXCx-PW65-xxxxx Emitter | | | | | |
|---|--------|--------|----------|--------|--------|
| Bin Code | x | y | Bin Code | x | y |
| 11 | 0.3158 | 0.3317 | 14 | 0.3119 | 0.3162 |
| | 0.3146 | 0.3422 | | 0.3103 | 0.3263 |
| | 0.3206 | 0.3481 | | 0.3158 | 0.3317 |
| | 0.3213 | 0.3371 | | 0.3170 | 0.3212 |
| 12 | 0.3170 | 0.3212 | 15 | 0.3048 | 0.3209 |
| | 0.3158 | 0.3317 | | 0.3028 | 0.3304 |
| | 0.3213 | 0.3371 | | 0.3087 | 0.3363 |
| | 0.3221 | 0.3261 | | 0.3103 | 0.3263 |
| 13 | 0.3103 | 0.3263 | 16 | 0.3068 | 0.3113 |
| | 0.3087 | 0.3363 | | 0.3048 | 0.3209 |
| | 0.3146 | 0.3422 | | 0.3103 | 0.3263 |
| | 0.3158 | 0.3317 | | 0.3119 | 0.3162 |

Notes for Table 21:

1. Tested and binned at 25°C and If = 100 mA. Tester tolerance: +/- 0.01 in x and y coordinates

Color Bin Structure, Continued

MXCx-PW65-xxxxx 1/9th Color Bin Structure

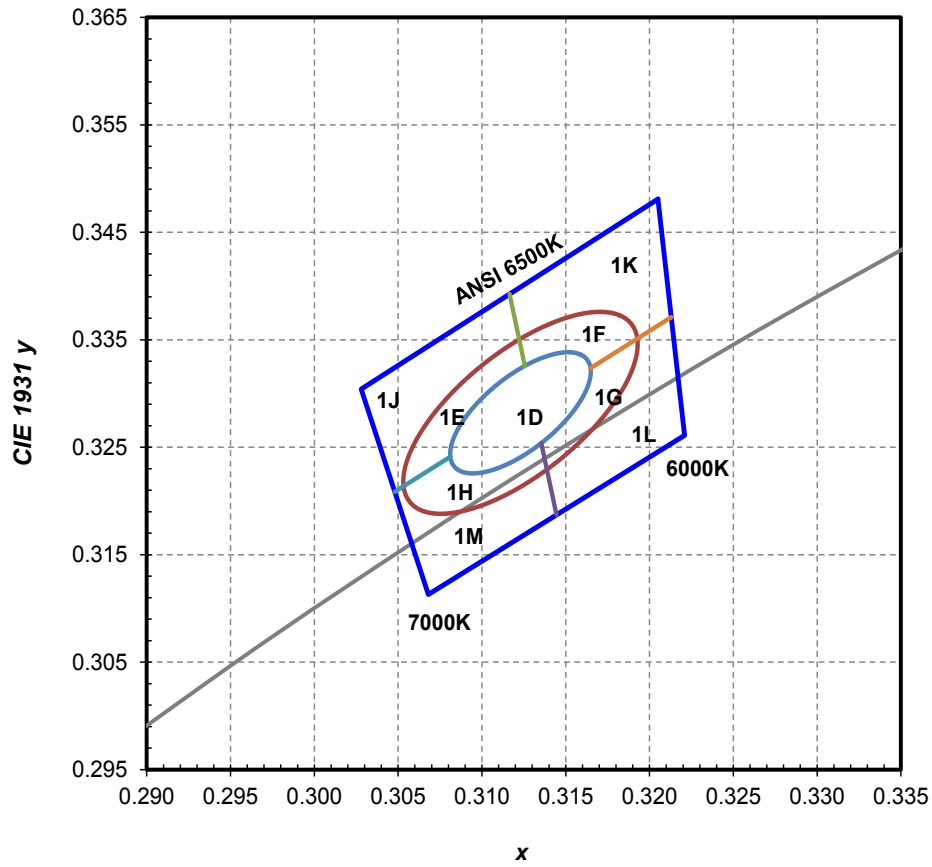

Figure 25. ANSI 6500K 1/9th color bin structure.

LUXEON Mid-Power Emitters are tested and binned by x,y coordinates.

Table 22.

| Nominal ANSI CCT | Color Space | Target Center Point (cx, cy) | Major Axis, a | Minor Axis, b | Ellipse Rotation Angle |
|------------------|-------------------------------|------------------------------|---------------|---------------|------------------------|
| 6500K | Single 3-step MacAdam ellipse | (0.3123, 0.3282) | 0.00669 | 0.00285 | 58.57° |
| 6500K | Single 5-step MacAdam ellipse | (0.3123, 0.3282) | 0.01115 | 0.00475 | 58.57° |

Notes for Table 22:

1. Tested and binned at 25°C and If = 100mA. Tester tolerance: +/- 0.01 in x and y coordinates.

About Lumileds

Lumileds is the light engine leader, delivering innovation, quality, and reliability.

For 100 years, Lumileds commitment to innovation has helped customers pioneer breakthrough products in the automotive, consumer and illumination markets.

Lumileds is shaping the future of light with our LEDs and automotive lamps, and helping our customers illuminate how people see the world around them.

To learn more about our portfolio of light engines visit www.lumileds.com.



©2015 Lumileds Holding B.V. All rights reserved.
LUXEON is a registered trademark of the Lumileds Holding B.V.
in the United States and other countries.

www.lumileds.com

Neither Lumileds Holding B.V. nor its affiliates shall be liable for any kind of loss of data or any other damages, direct, indirect or consequential, resulting from the use of the provided information and data. Although Lumileds Holding B.V. and/or its affiliates have attempted to provide the most accurate information and data, the materials and services information and data are provided "as is," and neither Lumileds Holding B.V. nor its affiliates warrants or guarantees the contents and correctness of the provided information and data. Lumileds Holding B.V. and its affiliates reserve the right to make changes without notice. You as user agree to this disclaimer and user agreement with the download or use of the provided materials, information and data.