

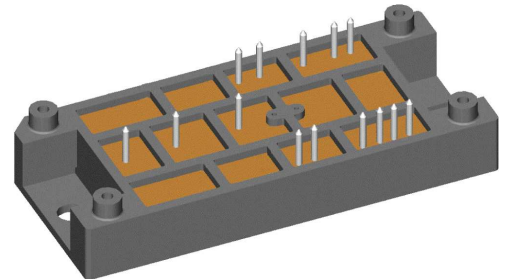
Standard Rectifier Module

3~ Rectifier	Brake Chopper
$V_{RRM} = 1600 \text{ V}$	$V_{CES} = 1200 \text{ V}$
$I_{DAV} = 180 \text{ A}$	$I_{C25} = 180 \text{ A}$
$I_{FSM} = 1100 \text{ A}$	$V_{CE(sat)} = 1.7 \text{ V}$

3~ Rectifier Bridge + Brake Unit

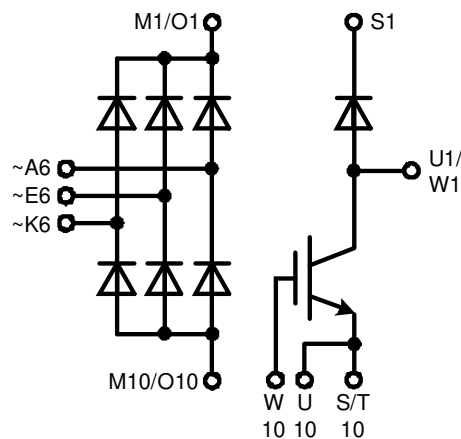
Part number

VUB120-16NOX



Backside: isolated

 E72873



Features / Advantages:

- Package with DCB ceramic base plate
- Improved temperature and power cycling
- Planar passivated chips
- Very low forward voltage drop
- Very low leakage current
- X2PT - 2nd generation Xtreme light Punch Through
- Rugged X2PT design results in:
 - short circuit rated for 10 μsec .
 - very low gate charge
 - low EMI
 - square RBSOA @ 2x I_c
- Thin wafer technology combined with X2PT design results in a competitive low $V_{CE(sat)}$ and low thermal resistance

Applications:

- 3~ Rectifier with brake unit for drive inverters

Package: V2-Pack

- Isolation Voltage: 3600 V~
- Industry standard outline
- RoHS compliant
- Soldering pins for PCB mounting
- Height: 17 mm
- Base plate: DCB ceramic
- Reduced weight
- Advanced power cycling

Disclaimer Notice

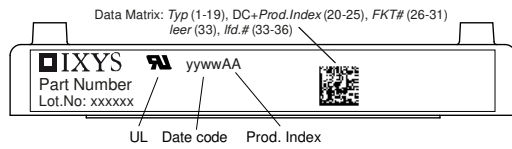
Information furnished is believed to be accurate and reliable. However, users should independently evaluate the suitability of and test each product selected for their own applications. Littelfuse products are not designed for, and may not be used in, all applications. Read complete Disclaimer Notice at www.littelfuse.com/disclaimer-electronics.

Rectifier				Ratings			
Symbol	Definition	Conditions		min.	typ.	max.	Unit
V_{RSM}	max. non-repetitive reverse blocking voltage					1700	V
V_{RRM}	max. repetitive reverse blocking voltage					1600	V
I_R	reverse current	$V_R = 1600$ V	$T_{VJ} = 25^\circ\text{C}$			100	μA
		$V_R = 1600$ V	$T_{VJ} = 125^\circ\text{C}$			2	mA
V_F	forward voltage drop	$I_F = 60$ A	$T_{VJ} = 25^\circ\text{C}$			1.16	V
		$I_F = 180$ A				1.55	V
		$I_F = 60$ A	$T_{VJ} = 125^\circ\text{C}$			1.09	V
		$I_F = 180$ A				1.59	V
I_{DAV}	bridge output current	$T_C = 90^\circ\text{C}$ rectangular	$T_{VJ} = 150^\circ\text{C}$ $d = \frac{1}{3}$			180	A
V_{FO}	threshold voltage	} for power loss calculation only				0.81	V
r_F	slope resistance					4.4	m Ω
R_{thJC}	thermal resistance junction to case					0.6	K/W
R_{thCH}	thermal resistance case to heatsink				0.2		K/W
P_{tot}	total power dissipation			$T_C = 25^\circ\text{C}$		205	W
I_{FSM}	max. forward surge current	$t = 10$ ms; (50 Hz), sine	$T_{VJ} = 45^\circ\text{C}$			1.10	kA
		$t = 8,3$ ms; (60 Hz), sine	$V_R = 0$ V			1.19	kA
		$t = 10$ ms; (50 Hz), sine	$T_{VJ} = 150^\circ\text{C}$			935	A
		$t = 8,3$ ms; (60 Hz), sine	$V_R = 0$ V			1.01	kA
I^2t	value for fusing	$t = 10$ ms; (50 Hz), sine	$T_{VJ} = 45^\circ\text{C}$			6.05	kA ² s
		$t = 8,3$ ms; (60 Hz), sine	$V_R = 0$ V			5.89	kA ² s
		$t = 10$ ms; (50 Hz), sine	$T_{VJ} = 150^\circ\text{C}$			4.37	kA ² s
		$t = 8,3$ ms; (60 Hz), sine	$V_R = 0$ V			4.25	kA ² s
C_J	junction capacitance	$V_R = 400$ V; $f = 1$ MHz		$T_{VJ} = 25^\circ\text{C}$		37	pF

Brake IGBT + Diode				Ratings			
Symbol	Definition	Conditions	min.	typ.	max.	Unit	
V_{CES}	collector emitter voltage	$T_{VJ} = 25^{\circ}\text{C}$			1200	V	
V_{GES}	max. DC gate voltage				± 20	V	
V_{GEM}	max. transient gate emitter voltage				± 30	V	
I_{C25}	collector current	$T_C = 25^{\circ}\text{C}$			180	A	
I_{C80}		$T_C = 80^{\circ}\text{C}$			140	A	
P_{tot}	total power dissipation	$T_C = 25^{\circ}\text{C}$			500	W	
$V_{CE(sat)}$	collector emitter saturation voltage	$I_C = 100\text{ A}; V_{GE} = 15\text{ V}$			1.7	V	
					1.9	V	
$V_{GE(th)}$	gate emitter threshold voltage	$I_C = 4\text{ mA}; V_{GE} = V_{CE}$	6	6.8	7.5	V	
I_{CES}	collector emitter leakage current	$V_{CE} = V_{CES}; V_{GE} = 0\text{ V}$			0.1	mA	
					0.1	mA	
I_{GES}	gate emitter leakage current	$V_{GE} = \pm 20\text{ V}$			500	nA	
$Q_{G(on)}$	total gate charge	$V_{CE} = 600\text{ V}; V_{GE} = 15\text{ V}; I_C = 100\text{ A}$		340		nC	
$t_{d(on)}$	turn-on delay time	inductive load $V_{CE} = 600\text{ V}; I_C = 100\text{ A}$ $V_{GE} = \pm 15\text{ V}; R_G = 6.8\ \Omega$	$T_{VJ} = 125^{\circ}\text{C}$		230	ns	
t_r	current rise time				70	ns	
$t_{d(off)}$	turn-off delay time				380	ns	
t_f	current fall time				230	ns	
E_{on}	turn-on energy per pulse				12.5	mJ	
E_{off}	turn-off energy per pulse				11.5	mJ	
RBSOA	reverse bias safe operating area	$V_{GE} = \pm 15\text{ V}; R_G = 6.8\ \Omega$					
I_{CM}		$V_{CEK} = 1200\text{ V}$			300	A	
SCSOA	short circuit safe operating area	$V_{CEK} = 1200\text{ V}$					
t_{SC}	short circuit duration	$V_{CE} = 720\text{ V}; V_{GE} = \pm 15$	$T_{VJ} = 125^{\circ}\text{C}$		10	μs	
I_{SC}	short circuit current	$R_G = 6.8\ \Omega$; non-repetitive		450		A	
R_{thJC}	thermal resistance junction to case				0.25	K/W	
R_{thCH}	thermal resistance case to heatsink			0.10		K/W	
Brake Diode							
V_{RRM}	max. repetitive reverse voltage				1200	V	
I_{F25}	forward current		$T_C = 25^{\circ}\text{C}$		48	A	
I_{F80}			$T_C = 80^{\circ}\text{C}$		32	A	
V_F	forward voltage	$I_F = 30\text{ A}$	$T_{VJ} = 25^{\circ}\text{C}$		2.75	V	
			$T_{VJ} = 125^{\circ}\text{C}$	1.60		V	
I_R	reverse current	$V_R = V_{RRM}$	$T_{VJ} = 25^{\circ}\text{C}$		0.25	mA	
			$T_{VJ} = 125^{\circ}\text{C}$		1	mA	
Q_{rr}	reverse recovery charge	$V_R = 600\text{ V}$ $-di_f/dt = 1000\text{ A}/\mu\text{s}$ $I_F = 30\text{ A}; V_{GE} = 0\text{ V}$	$T_{VJ} = 125^{\circ}\text{C}$		5.2	μC	
I_{RM}	max. reverse recovery current				50	A	
t_{rr}	reverse recovery time				300	ns	
E_{rec}	reverse recovery energy				1.9	mJ	
R_{thJC}	thermal resistance junction to case				0.9	K/W	
R_{thCH}	thermal resistance case to heatsink			0.3		K/W	



Package V2-Pack		Ratings				
Symbol	Definition	Conditions	min.	typ.	max.	Unit
I_{RMS}	RMS current	per terminal			100	A
T_{VJ}	virtual junction temperature		-40		150	°C
T_{op}	operation temperature		-40		125	°C
T_{stg}	storage temperature		-40		125	°C
Weight				76		g
M_D	mounting torque		2		2.5	Nm
$d_{Spp/APP}$	creepage distance on surface / striking distance through air	terminal to terminal	6.0			mm
$d_{Spb/APb}$		terminal to backside	12.0			mm
V_{ISOL}	isolation voltage	t = 1 second	3600			V
		t = 1 minute	3000			V



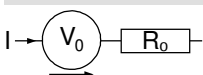
Ordering	Ordering Number	Marking on Product	Delivery Mode	Quantity	Code No.
Standard	VUB120-16NOX	VUB120-16NOX	Box	6	520475

Similar Part	Package	Voltage class
VUB120-16NOXT	V2-Pack	1600

Equivalent Circuits for Simulation

* on die level

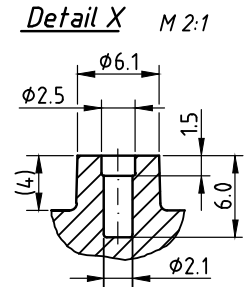
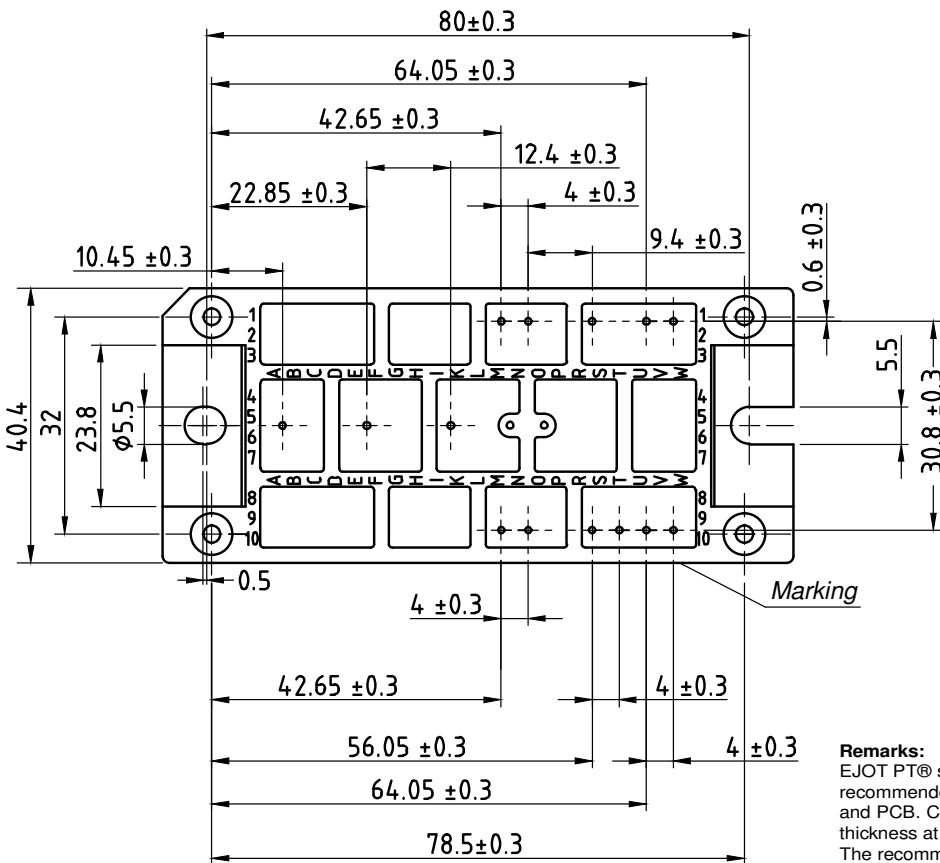
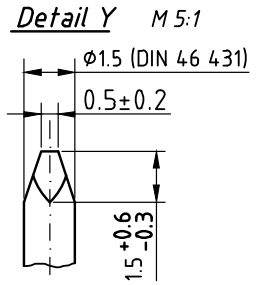
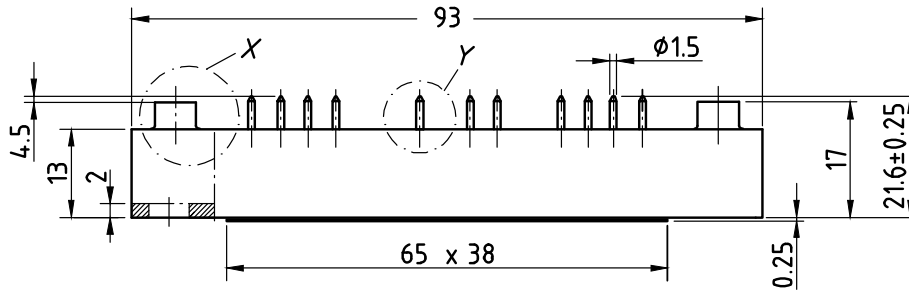
$T_{VJ} = 150^{\circ}\text{C}$



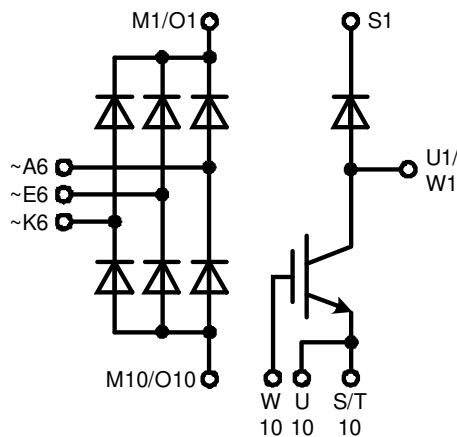
	Rectifier	Brake Diode	
$V_{0 \max}$	0.81	1.31	V
$R_{0 \max}$	3.2	8	mΩ



Outlines V2-Pack



Remarks:
EJOT PT® self-tapping screws of the dimension K25 are recommended for the mechanical connection between module and PCB. Choose the right length according to your board thickness at a maximum depth of 6 mm of the module holes. The recommended mounting torque is 1.5 Nm.





Rectifier

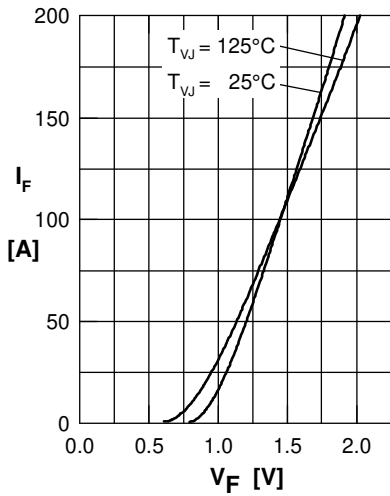


Fig. 1 Forward current vs. voltage drop per diode

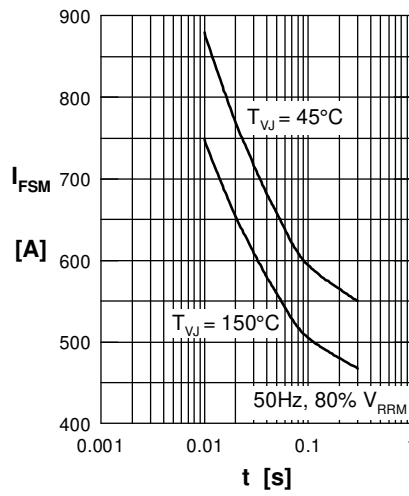


Fig. 2 Surge overload current vs. time per diode

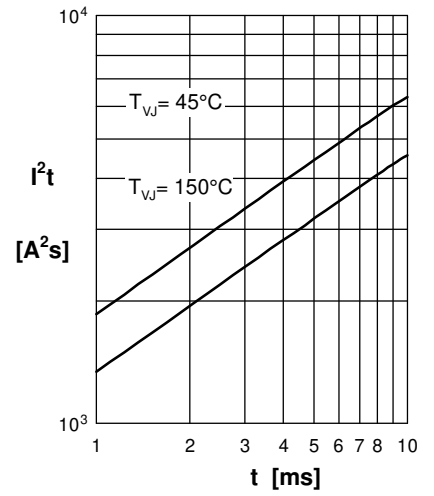


Fig. 3 I^2t vs. time per diode

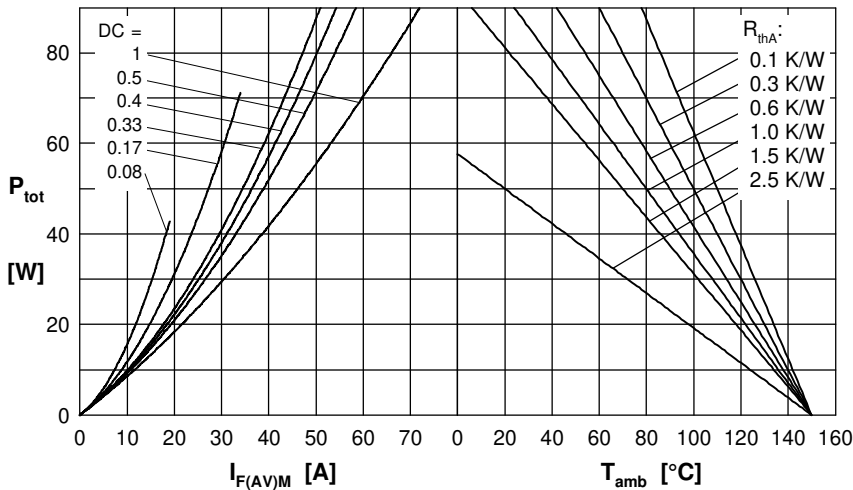


Fig. 4 Power dissipation vs. forward current and ambient temperature per diode

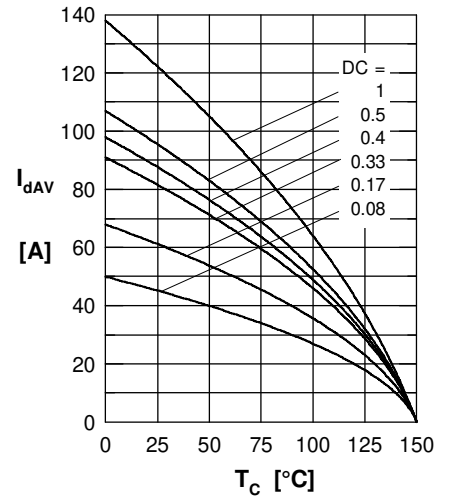


Fig. 5 Max. forward current vs. case temperature per diode

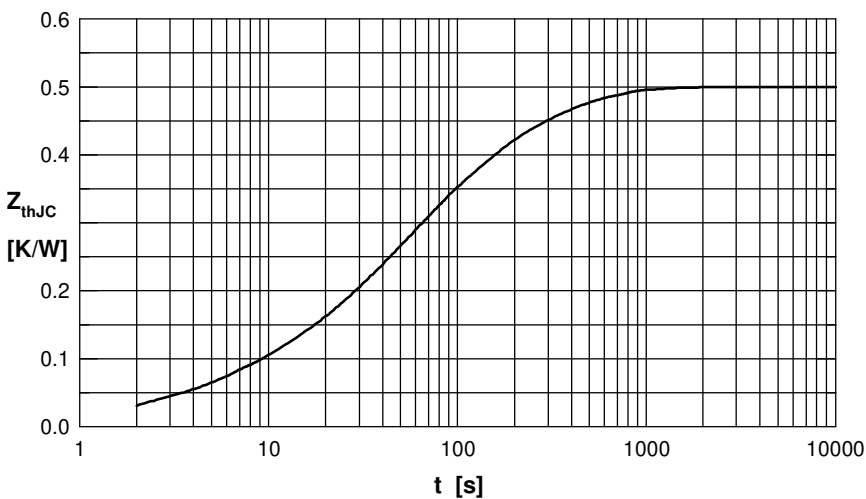


Fig. 6 Transient thermal impedance junction to case vs. time per diode

Constants for Z_{thJC} calculation:

i	R_{th} (K/W)	t_i (s)
1	0.040	0.004
2	0.003	0.010
3	0.140	0.030
4	0.120	0.300
5	0.197	0.080

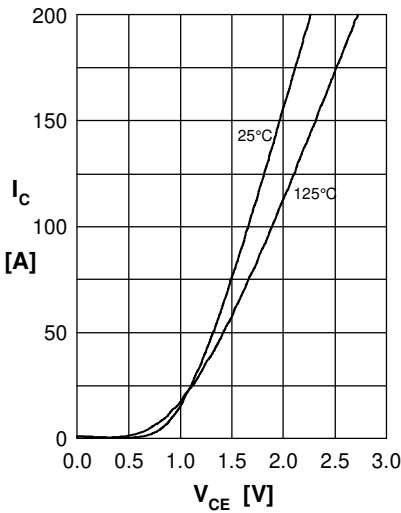
Brake IGBT + Diode


Fig.1 Output characteristics IGBT

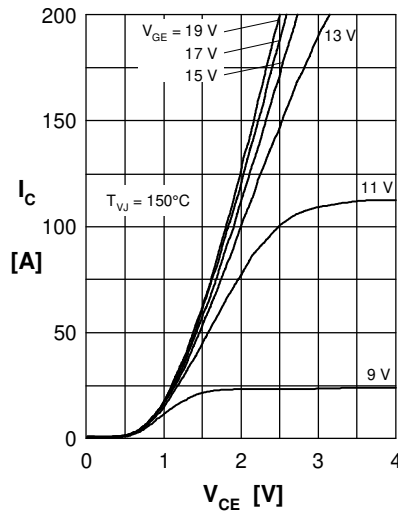


Fig.2 Typ. output characteristics IGBT

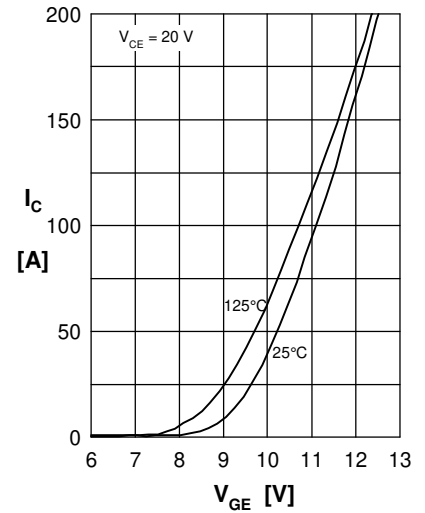


Fig.3 Typ. transfer charact. IGBT

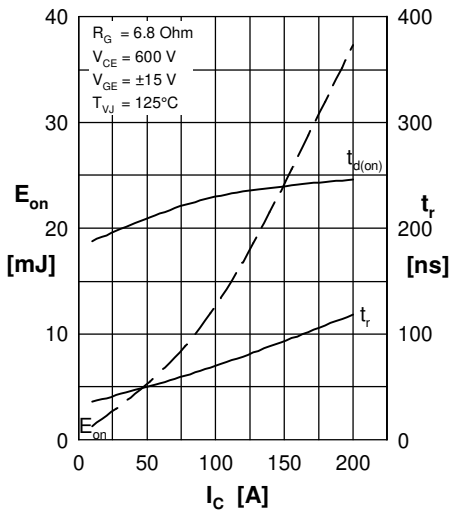


Fig.4 Typ. turn-on energy & switch. times vs. collector current

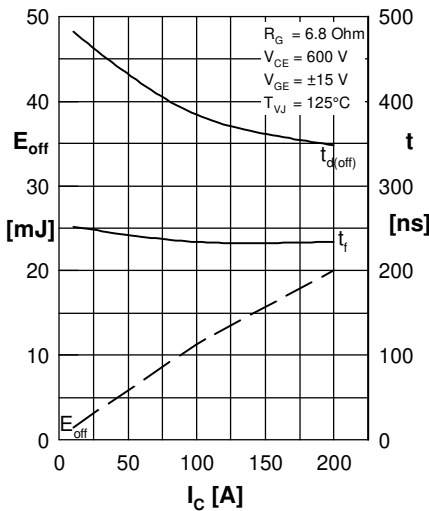


Fig.5 Typ. turn-off energy & switch. times vs. collector current

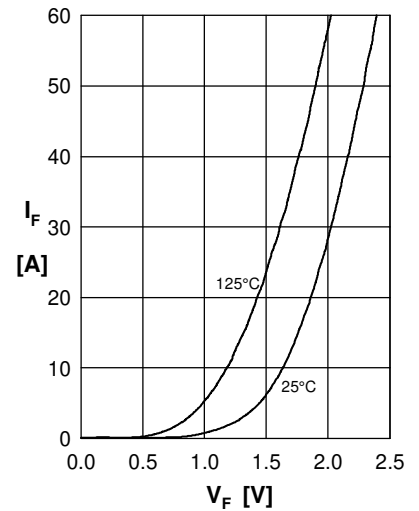


Fig.6 Typ. forward characteristics Diode

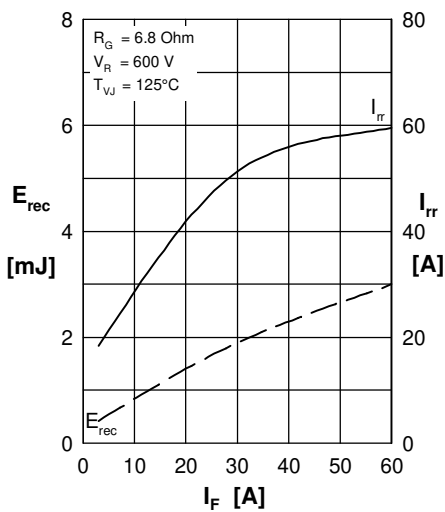


Fig.7 Typ. reverse recovery characteristics Diode

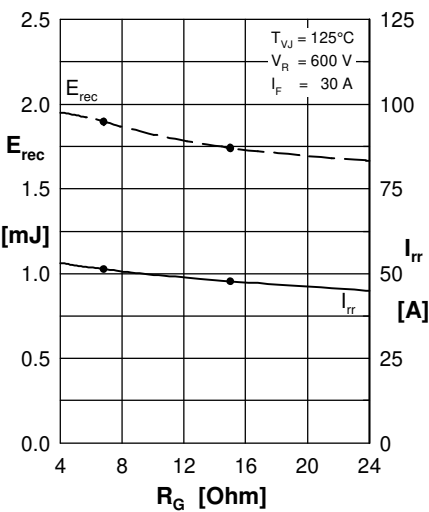


Fig.8 Typ. reverse recovery characteristics Diode

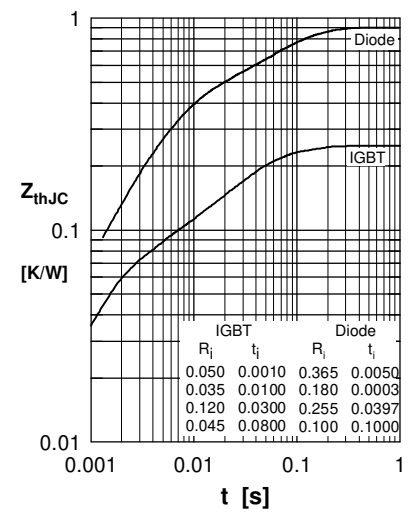


Fig.9 Transient thermal resistance junction to case