

## **TPS92315EVM User's Guide**

The TPS92315EVM is an LED driver for GU-10 applications. The design focuses on applications that require a small form factor and a minimal number of external components, such that the dimension of the PCB is only 31 mm × 18 mm × 12 mm (L × W × H). The EVM accepts a wide AC line input range from 85 to 250 VRMS, and regulates 350-mA current into a single LED string with 3 LEDs in series. The EVM is designed for the EN 55022 class B standard. This user's guide details the specification, schematic, PCB layout, testing, results, and bill of materials of the EVM.

### Contents

1	Introduction .....	2
2	Description .....	2
3	Typical Applications .....	2
4	Electrical Performance Specifications .....	2
5	Schematic .....	3
	5.1 Test Equipment .....	4
6	Board Connection .....	4
7	TPS92315EVM Test Procedure .....	4
8	Typical Performance Characteristics .....	5
9	Electromagnetic Interference (EMI) .....	7
10	Assembly Drawings and PCB Layout .....	9
11	Bill of Materials .....	10

### List of Figures

1	Schematic of the TPS92315EVM .....	3
2	Typical Connection Block Diagram .....	4
3	Waveforms of Power-up Transient of TPS92315EVM with $V_{IN} = 110V_{AC}$ (Ch 1: Drain Voltage of $Q_1$ ; Ch 3: $V_{LED}$ ; Ch 4: $I_{LED}$ ) .....	5
4	Waveforms of Steady State Operation of TPS92315EVM with $V_{IN} = 110V_{AC}$ (Ch 1: Drain Voltage of $Q_1$ ; Ch 3: Source Voltage of $Q_1$ ; Ch 4: $I_{LED}$ ) .....	6
5	Peak Conductive EMI per EN55022 Class B Limits (110 VAC Live) .....	7
6	Peak Conductive EMI per EN55022 Class B Limits (110 VAC Neutral) .....	7
7	Peak Conductive EMI per EN55022 Class B Limits (230 VAC Live) .....	8
8	Peak Conductive EMI per EN55022 Class B Limits (230 VAC Neutral) .....	8
9	Top Layer PCB .....	9
10	Bottom Layer PCB .....	9

### List of Tables

1	TPS92315EVM .....	2
2	Board Connection Description .....	4
3	Connections .....	4
4	Functional AC Input Test .....	5
5	Bill of Materials .....	10

## 1 Introduction

The TPS92315EVM is an LED driver for GU-10 applications. The design focuses on applications that require a small form factor and a minimal number of external components, such that the dimension of the PCB is only 31 mm × 18 mm × 12 mm (L × W × H). The EVM accepts a wide AC line input range from 85 to 250 VRMS, and regulates 350-mA current into a single LED string with 3 LEDs in series. The EVM is designed for the EN 55022 class B standard. This user's guide details the specification, schematic, PCB layout, testing, results, and bill of materials of the EVM.

## 2 Description

The TPS92315EVM is controlled by the TPS92315, which is a single-stage AC/DC controller dedicated for GU-10 applications. The circuit senses primary-side current so current sensing and feedback from the secondly side are not required. It employs the flyback topology, working in the discontinuous conduction mode (DCM) and controlling by peak current detection. To minimize the switching loss of the MOSFET, EMI, and the turn-on current spike at the sensing resistor, the TPS92315 implements a valley switching method, aimed at turning on the MOSFET when the drain-to-source voltage of the MOSFET is near the minimum. The over-voltage protection (OVP) and over-current protection (OCP) of the TPS92315 helps protect the circuit during LED open and short.

## 3 Typical Applications

LED lamps:

- GU-10

Features

- Universal line input: 90 VRMS – 264 VRMS
- Primary-side sensing to achieve LED current regulation
- Valley switching benefitting the EMI and efficiency
- Flyback topology with discontinuous conduction mode (DCM) and peak current control
- LED current setting with external sense resistor

## 4 Electrical Performance Specifications

**Table 1. TPS92315EVM**

Parameter		Test Conditions	Min	Typ	Max	Unit
<b>Input Characteristics</b>						
$V_{IN}$	Input Voltage		90		264	V
$I_Q$	Input quiescent Current	Device enable, $V_{IN} = 48\text{ V}$ , $V_{DIM} = 1\text{ V}$ , no switching			3	mA
<b>Output Characteristics</b>						
$V_{OUT}$	Output Voltage	LED+ to LED-	8.5		11	V
$I_{LED}$	LED Current	$V_{OUT} = 9\text{ V}$	335	350	365	mA
<b>SYSTEMS CHARACTERISTICS</b>						
$\eta$	Efficiency	$90\text{ V}_{AC} < V_{IN} < 264\text{ V}_{AC}$ , $V_{OUT} = 9\text{ V}$ , $I_{LED} = 350\text{ mA}$	70		85	%

5 Schematic

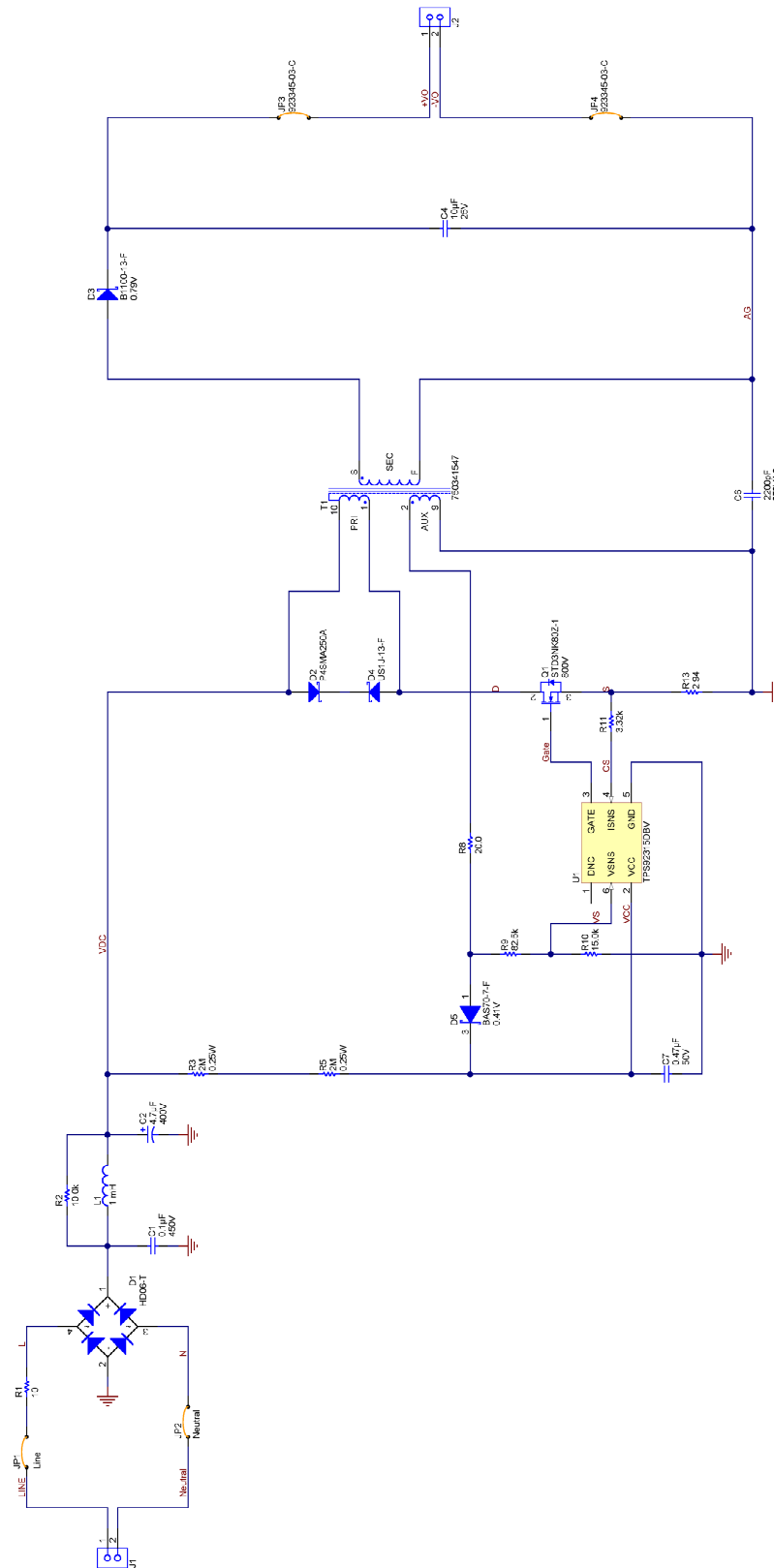

Figure 1. Schematic of the TPS92315EVM

### 5.1 Test Equipment

- **Voltage Source:** Start at 90 VRMS–264 VRMS; AC source: PCR500LA (KIKUSUI)
- **Multimeter:** Agilent 34401A
- **Power meter:** WT210 Digital Power Meter (YOKOGAWA)
- **LED Load:** 3 LEDs in series (LED forward voltage = 3.0 V each at 350 mA)
- **Oscilloscope:** TDS3054C (TEKTRONIX)
- **Operation temperature:** 25°C

## 6 Board Connection

Figure 2 illustrates the board connections for the TPS92315EVM.

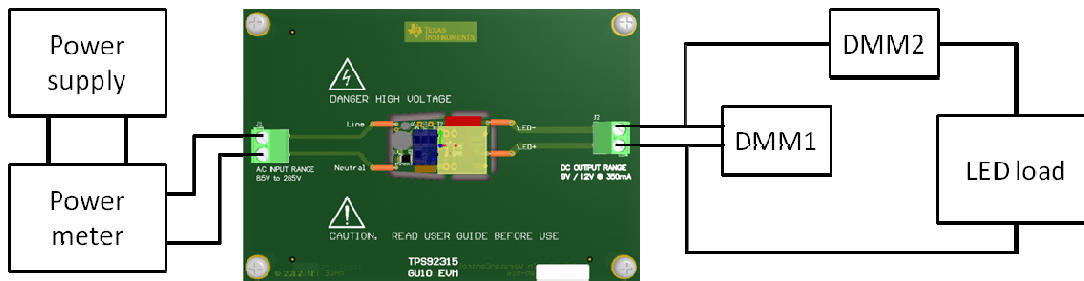

Figure 2. Typical Connection Block Diagram

Table 2. Board Connection Description

Terminal Designation	Description
AC Live	Connect to a 110 V <sub>AC</sub> or 220 V <sub>AC</sub> directly or through a power meter
AC Neutral	
LED+	Connect to the LED string directly or through an ammeter
LED-	

## 7 TPS92315EVM Test Procedure

### CAUTION

High voltage levels are present on the evaluation module whenever it is energized. Proper precautions must be taken when working with the EVM. Serious injury can occur if proper safety precautions are not followed.

Table 3. Connections

Step	Operation	Remarks
1	Connect the AC mains or an AC source to a power meter	The power meter can be by-passed
2	Connect the TPS92315EVM to the power meter	Connect to the line and neutral terminals of the TPS92315EVM
3	Connect the LED load to the TPS92315EVM	Connect to the LED+ and LED- terminals of the TPS92315EVM

**Table 4. Functional AC Input Test**

Step	Operation	Remarks
1	Set the AC source output between 85 to 250 V <sub>AC</sub>	
2	Turn on the AC power	The LED current is 350 mA ± 5%
3	Turn off the AC power	Do not touch any connection within 2 seconds after power off

**8 Typical Performance Characteristics**

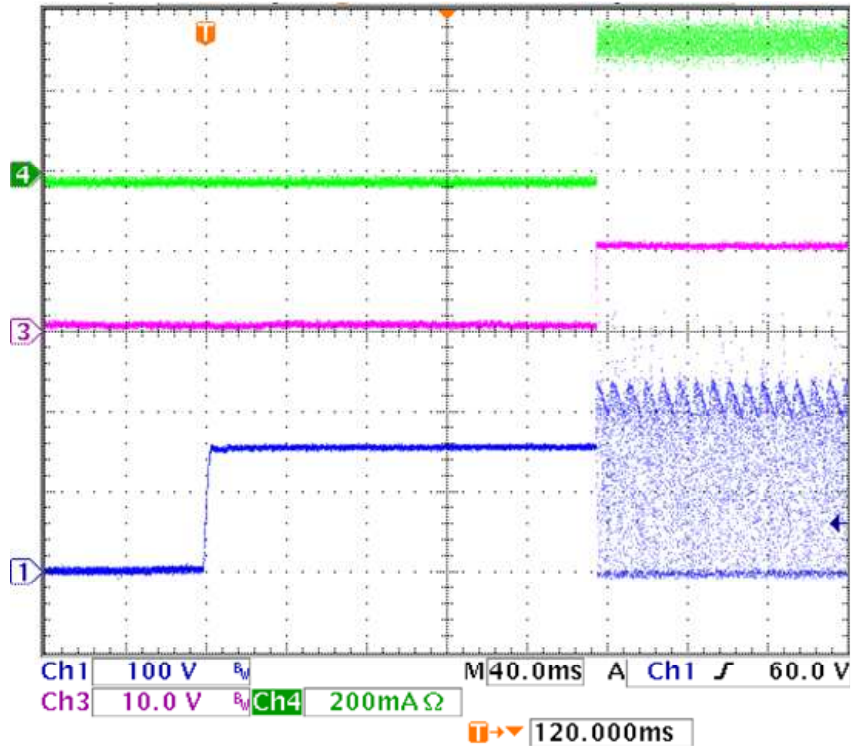

**Figure 3. Waveforms of Power-up Transient of TPS92315EVM with V<sub>IN</sub> = 110V<sub>AC</sub> (Ch 1: Drain Voltage of Q<sub>1</sub>; Ch 3: V<sub>LED</sub>; Ch 4: I<sub>LED</sub>)**

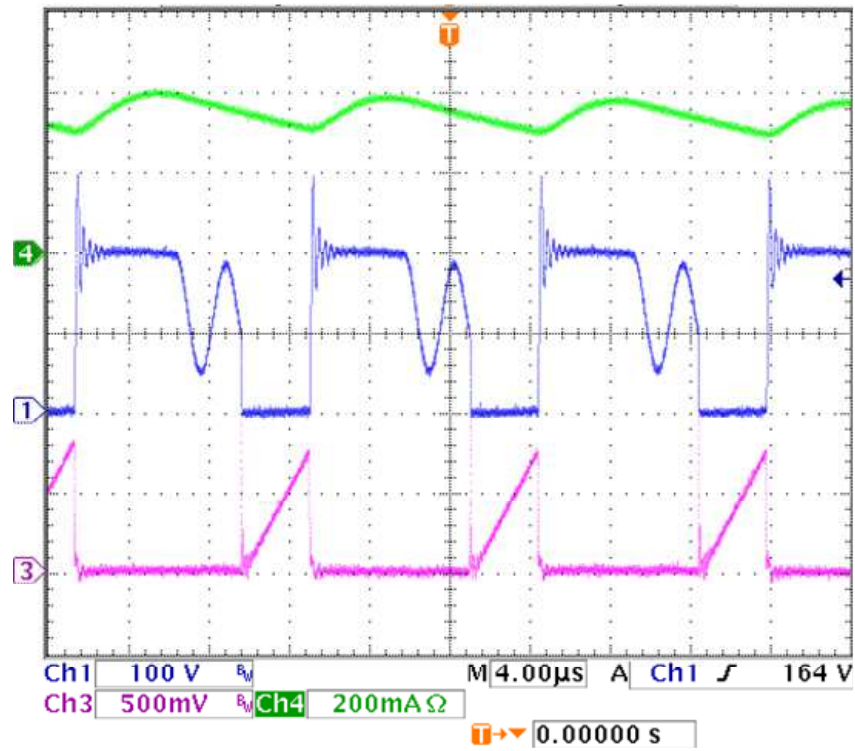
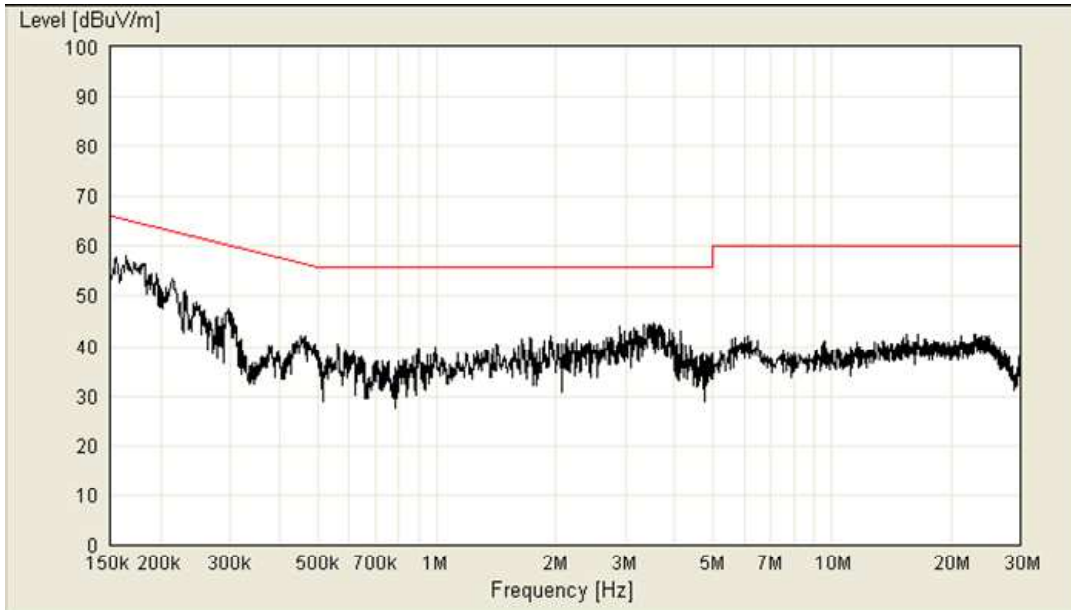

Figure 4. Waveforms of Steady State Operation of TPS92315EVM with  $V_{IN} = 110V_{AC}$   
 (Ch 1: Drain Voltage of  $Q_1$ ; Ch 3: Source Voltage of  $Q_1$ ; Ch 4:  $I_{LED}$ )

## 9 Electromagnetic Interference (EMI)

Figure 5 through Figure 8 show the peak conductive EMI scans. Data are compared with the EN 55022 Class B conducted EMI limits. All tests are under the conditions that the LED voltage, LED current, and output power are 9.2 V, 350 mA, and 3.2 W, respectively.



**Figure 5. Peak Conductive EMI per EN55022 Class B Limits (110 VAC Live)**

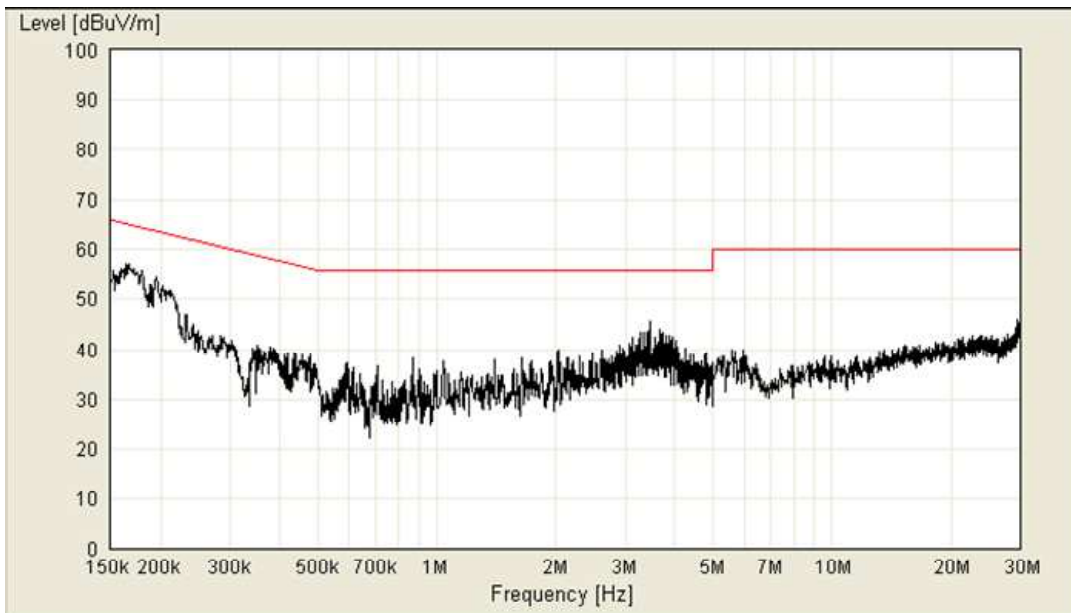

**Figure 6. Peak Conductive EMI per EN55022 Class B Limits (110 VAC Neutral)**

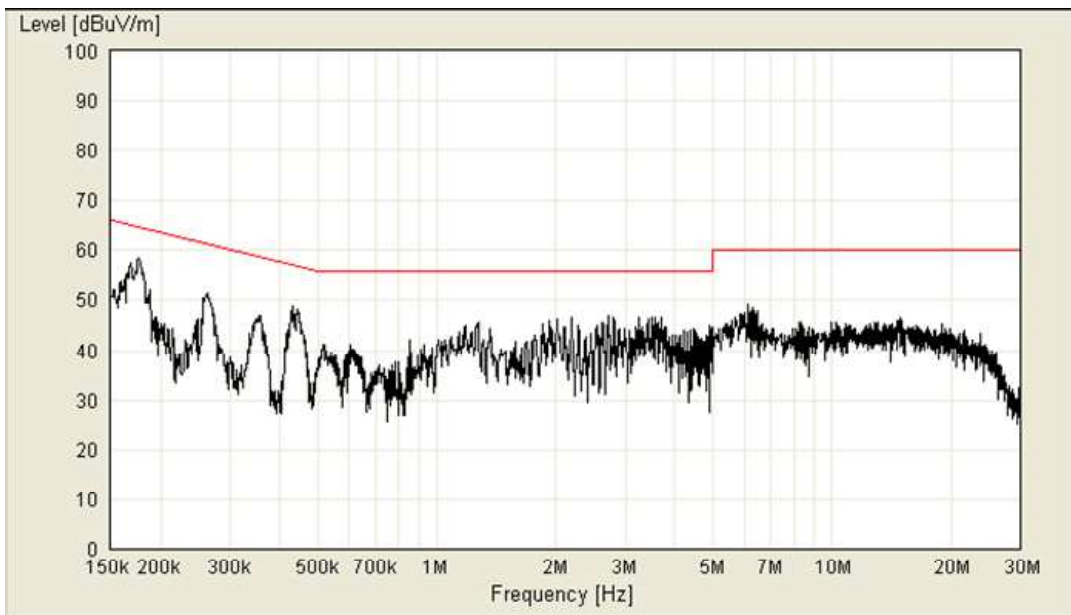

Figure 7. Peak Conductive EMI per EN55022 Class B Limits (230 VAC Live)

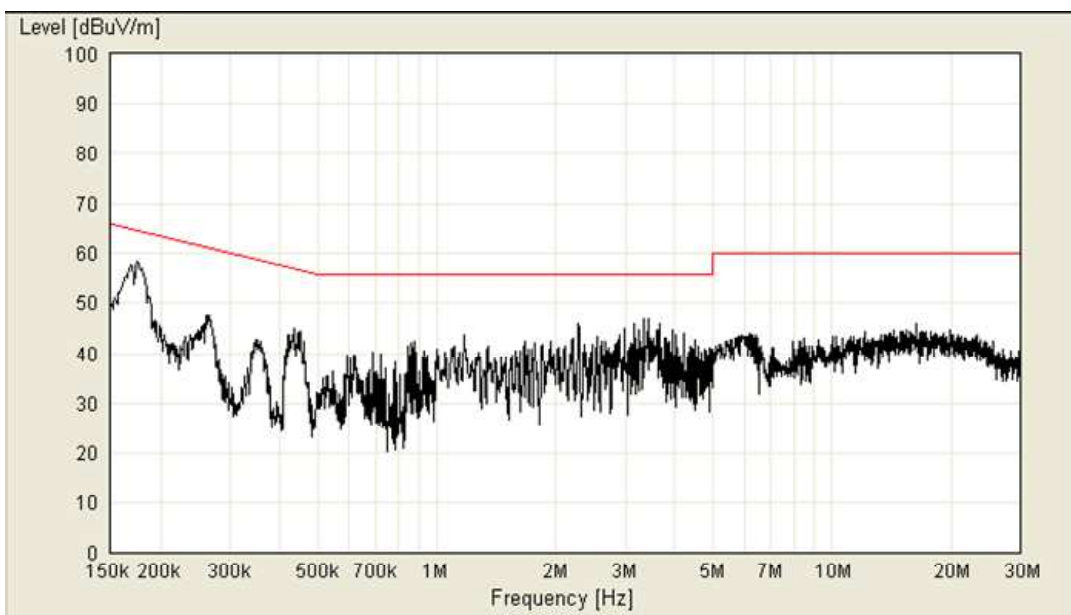

Figure 8. Peak Conductive EMI per EN55022 Class B Limits (230 VAC Neutral)



10 Assembly Drawings and PCB Layout

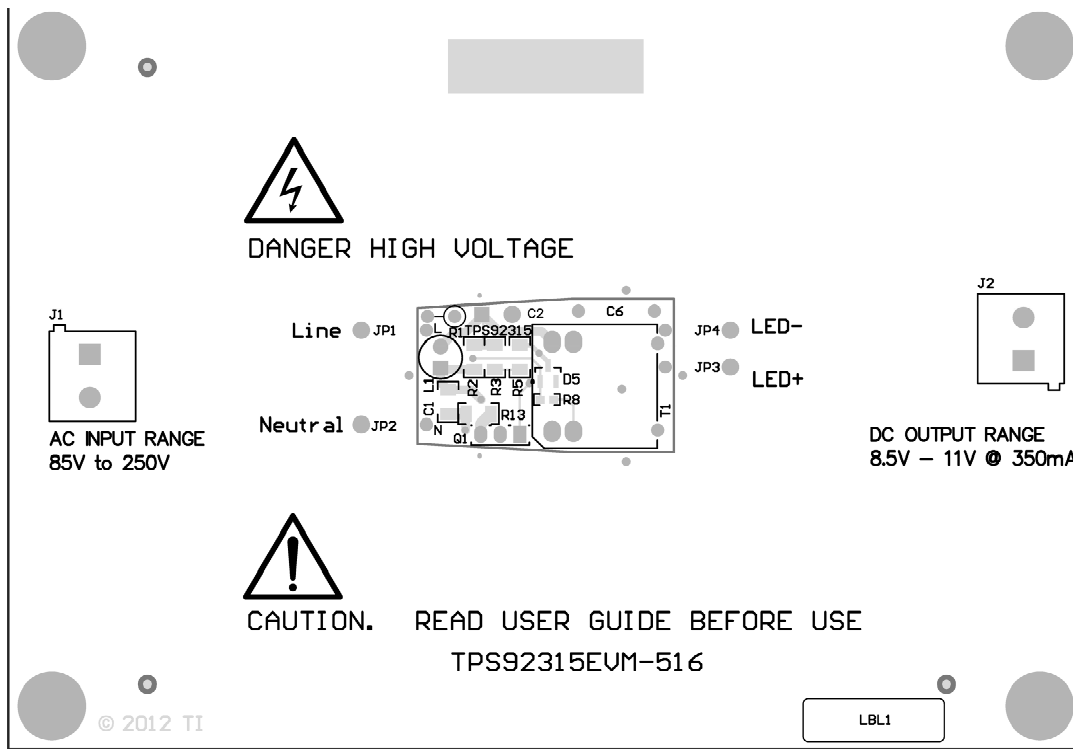

Figure 9. Top Layer PCB

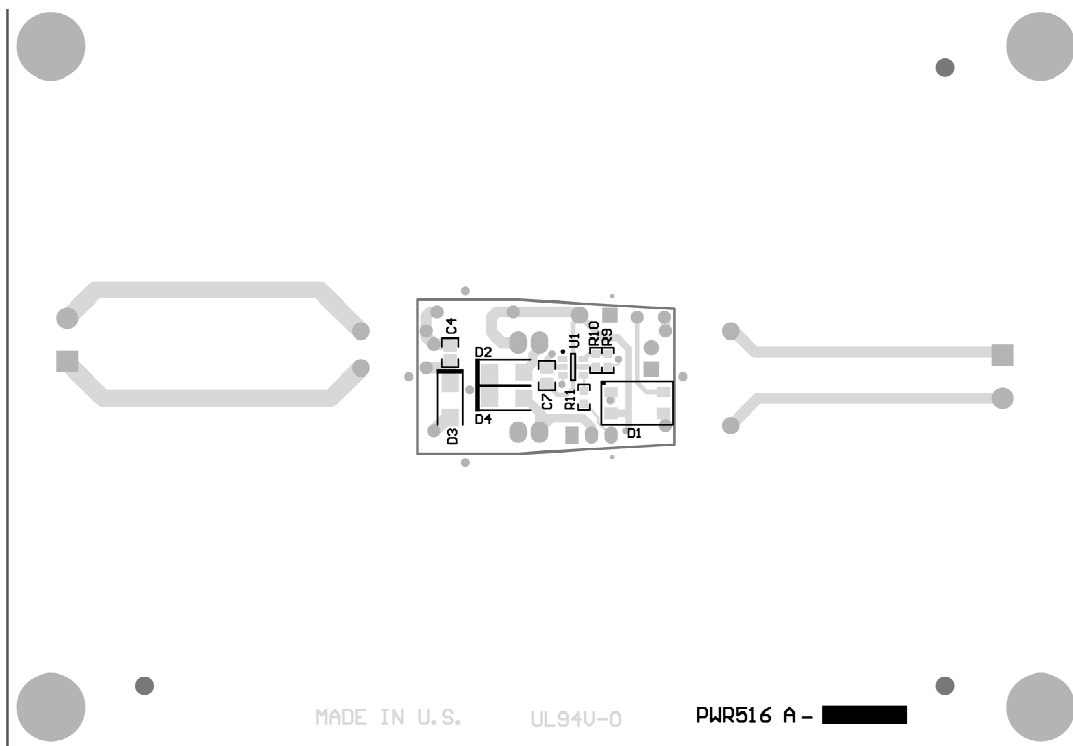

Figure 10. Bottom Layer PCB

**11 Bill of Materials**
**Table 5. Bill of Materials**

Item	Designator	Description	Manufacturer	Part Number
1	C1	Capacitor, ceramic, 0.1 $\mu$ F, 450V, 10%, X7T, 1206	TDK Corporation	C3216X7T2W104K
2	C2	Capacitor, Aluminum, 4.7 $\mu$ F, 400V, 20%, Radial 8mm x 11.5mm	Nichicon	UVC2G4R7MPD
			Nippon Chemi-con Corporation	ECLE401ELL4R7MHB5D
3	C4	Capacitor, ceramic, 10 $\mu$ F, 25V, 10%, X5R, 0805	Taiyo Yuden	TMK212BBJ106KG-T
4	C6	Capacitor, ceramic, 2200pF, 250V, 20%, THT X1Y1	Murata Electronics North America	DE1E3KX222MA5BA01
5	C7	Capacitor, ceramic, 0.47 $\mu$ F, 50V, 10%, X7R, 0805	TDK Corporation	C2012X7R1H474K
6	D1	Diode, Switching-Bridge, 600V, 0.8A, MiniDIP	Diodes Inc	HD06-T
7	D2	Diode, TVS, 400W 250V, UNI 5%, SMD	Littelfuse Inc	P4SMA250A
8	D3	Diode, Schottky, 100V, 1A, SMA	Diodes Inc.	B1100-13-F
9	D4	Diode, Ultrafast, 600V, 1A, SMA	Diodes Inc.	US1J-13-F
10	D5	Diode, Schottky, 70V, 0.07A, SOT-23	Diodes Inc.	BAS70-7-F
11	H1, H2, H3, H4	Machine Screw, Round, #4-40 x 1/4, Nylon, Philips panhead	B&F Fastener Supply	NY PMS 440 0025 PH
12	H5, H6, H7, H8	Standoff, Hex, 0.5"L #4-40 Nylon	Keystone	1902C
13	J1, J2	Conn Term Block, 2POS, 5.08mm PCB	Phoenix Contact	1715721
14	JP1, JP2, JP3, JP4	Jumper Wire, 300mil spacing, Orange, pkg of 200	3M	923345-03-C
15	L1	Fixed Inductors, 1mH, 0.14A, Radial Lead	Sumida	RCH4764NP-102K
16	Q1	MOSFET, N-CH, 800V, 2.5A, TO-251AB	ST Microelectronics	STD3NK80Z1
17	R1	Resistor, fusible WW, 10 $\Omega$ , 1W, 5%	Yageo	FKN1WSJR52-10R
				FAE1WSJR-52-10R
18	R2	Resistor, 10.0k $\Omega$ , 1%, 0.25W, 1206	Vishay-Dale	CRCW120610K0FKEA
19	R3, R5	Resistor, 2.00M $\Omega$ , 1%, 0.25W, 1206	Yageo	RC1206FR072ML
20	R8	Resistor, 20.0 $\Omega$ , 1%, 0.1W, 0603	Vishay-Dale	CRCW060320R0FKEA
21	R9	Resistor, 82.5k $\Omega$ , 1%, 0.1W, 0603	Vishay-Dale	CRCW060382K5FKEA
22	R10	Resistor, 15.0k $\Omega$ , 1%, 0.1W, 0603	Vishay-Dale	CRCW060315K0FKEA
23	R11	Resistor, 3.32k $\Omega$ , 1%, 0.1W, 0603	Vishay-Dale	CRCW06033K32FKEA
24	R13	Resistor, 2.94 $\Omega$ , 1%, 0.25W, 1206	Vishay-Dale	CRCW12062R94FKEA
25	T1	Transformer EE-16, TH	Würth Elektronik eiSos	750341547
26	U1	Off-Line Primary-Side Sensing Controller, DBV0006A	Texas Instruments	TPS92315DBV

## EVALUATION BOARD/KIT/MODULE (EVM) ADDITIONAL TERMS

Texas Instruments (TI) provides the enclosed Evaluation Board/Kit/Module (EVM) under the following conditions:

The user assumes all responsibility and liability for proper and safe handling of the goods. Further, the user indemnifies TI from all claims arising from the handling or use of the goods.

Should this evaluation board/kit not meet the specifications indicated in the User's Guide, the board/kit may be returned within 30 days from the date of delivery for a full refund. THE FOREGOING LIMITED WARRANTY IS THE EXCLUSIVE WARRANTY MADE BY SELLER TO BUYER AND IS IN LIEU OF ALL OTHER WARRANTIES, EXPRESSED, IMPLIED, OR STATUTORY, INCLUDING ANY WARRANTY OF MERCHANTABILITY OR FITNESS FOR ANY PARTICULAR PURPOSE. EXCEPT TO THE EXTENT OF THE INDEMNITY SET FORTH ABOVE, NEITHER PARTY SHALL BE LIABLE TO THE OTHER FOR ANY INDIRECT, SPECIAL, INCIDENTAL, OR CONSEQUENTIAL DAMAGES.

Please read the User's Guide and, specifically, the Warnings and Restrictions notice in the User's Guide prior to handling the product. This notice contains important safety information about temperatures and voltages. For additional information on TI's environmental and/or safety programs, please visit [www.ti.com/esh](http://www.ti.com/esh) or contact TI.

No license is granted under any patent right or other intellectual property right of TI covering or relating to any machine, process, or combination in which such TI products or services might be or are used. TI currently deals with a variety of customers for products, and therefore our arrangement with the user is not exclusive. TI assumes no liability for applications assistance, customer product design, software performance, or infringement of patents or services described herein.

## REGULATORY COMPLIANCE INFORMATION

As noted in the EVM User's Guide and/or EVM itself, this EVM and/or accompanying hardware may or may not be subject to the Federal Communications Commission (FCC) and Industry Canada (IC) rules.

For EVMs **not** subject to the above rules, this evaluation board/kit/module is intended for use for ENGINEERING DEVELOPMENT, DEMONSTRATION OR EVALUATION PURPOSES ONLY and is not considered by TI to be a finished end product fit for general consumer use. It generates, uses, and can radiate radio frequency energy and has not been tested for compliance with the limits of computing devices pursuant to part 15 of FCC or ICES-003 rules, which are designed to provide reasonable protection against radio frequency interference. Operation of the equipment may cause interference with radio communications, in which case the user at his own expense will be required to take whatever measures may be required to correct this interference.

### General Statement for EVMs including a radio

*User Power/Frequency Use Obligations:* This radio is intended for development/professional use only in legally allocated frequency and power limits. Any use of radio frequencies and/or power availability of this EVM and its development application(s) must comply with local laws governing radio spectrum allocation and power limits for this evaluation module. It is the user's sole responsibility to only operate this radio in legally acceptable frequency space and within legally mandated power limitations. Any exceptions to this are strictly prohibited and unauthorized by Texas Instruments unless user has obtained appropriate experimental/development licenses from local regulatory authorities, which is responsibility of user including its acceptable authorization.

### For EVMs annotated as FCC – FEDERAL COMMUNICATIONS COMMISSION Part 15 Compliant

#### Caution

This device complies with part 15 of the FCC Rules. Operation is subject to the following two conditions: (1) This device may not cause harmful interference, and (2) this device must accept any interference received, including interference that may cause undesired operation.

Changes or modifications not expressly approved by the party responsible for compliance could void the user's authority to operate the equipment.

### FCC Interference Statement for Class A EVM devices

This equipment has been tested and found to comply with the limits for a Class A digital device, pursuant to part 15 of the FCC Rules. These limits are designed to provide reasonable protection against harmful interference when the equipment is operated in a commercial environment. This equipment generates, uses, and can radiate radio frequency energy and, if not installed and used in accordance with the instruction manual, may cause harmful interference to radio communications. Operation of this equipment in a residential area is likely to cause harmful interference in which case the user will be required to correct the interference at his own expense.

### **FCC Interference Statement for Class B EVM devices**

This equipment has been tested and found to comply with the limits for a Class B digital device, pursuant to part 15 of the FCC Rules. These limits are designed to provide reasonable protection against harmful interference in a residential installation. This equipment generates, uses and can radiate radio frequency energy and, if not installed and used in accordance with the instructions, may cause harmful interference to radio communications. However, there is no guarantee that interference will not occur in a particular installation. If this equipment does cause harmful interference to radio or television reception, which can be determined by turning the equipment off and on, the user is encouraged to try to correct the interference by one or more of the following measures:

- Reorient or relocate the receiving antenna.
- Increase the separation between the equipment and receiver.
- Connect the equipment into an outlet on a circuit different from that to which the receiver is connected.
- Consult the dealer or an experienced radio/TV technician for help.

### **For EVMs annotated as IC – INDUSTRY CANADA Compliant**

This Class A or B digital apparatus complies with Canadian ICES-003.

Changes or modifications not expressly approved by the party responsible for compliance could void the user's authority to operate the equipment.

### **Concerning EVMs including radio transmitters**

This device complies with Industry Canada licence-exempt RSS standard(s). Operation is subject to the following two conditions: (1) this device may not cause interference, and (2) this device must accept any interference, including interference that may cause undesired operation of the device.

### **Concerning EVMs including detachable antennas**

Under Industry Canada regulations, this radio transmitter may only operate using an antenna of a type and maximum (or lesser) gain approved for the transmitter by Industry Canada. To reduce potential radio interference to other users, the antenna type and its gain should be so chosen that the equivalent isotropically radiated power (e.i.r.p.) is not more than that necessary for successful communication.

This radio transmitter has been approved by Industry Canada to operate with the antenna types listed in the user guide with the maximum permissible gain and required antenna impedance for each antenna type indicated. Antenna types not included in this list, having a gain greater than the maximum gain indicated for that type, are strictly prohibited for use with this device.

Cet appareil numérique de la classe A ou B est conforme à la norme NMB-003 du Canada.

Les changements ou les modifications pas expressément approuvés par la partie responsable de la conformité ont pu vider l'autorité de l'utilisateur pour actionner l'équipement.

### **Concernant les EVMs avec appareils radio**

Le présent appareil est conforme aux CNR d'Industrie Canada applicables aux appareils radio exempts de licence. L'exploitation est autorisée aux deux conditions suivantes : (1) l'appareil ne doit pas produire de brouillage, et (2) l'utilisateur de l'appareil doit accepter tout brouillage radioélectrique subi, même si le brouillage est susceptible d'en compromettre le fonctionnement.

### **Concernant les EVMs avec antennes détachables**

Conformément à la réglementation d'Industrie Canada, le présent émetteur radio peut fonctionner avec une antenne d'un type et d'un gain maximal (ou inférieur) approuvé pour l'émetteur par Industrie Canada. Dans le but de réduire les risques de brouillage radioélectrique à l'intention des autres utilisateurs, il faut choisir le type d'antenne et son gain de sorte que la puissance isotrope rayonnée équivalente (p.i.r.e.) ne dépasse pas l'intensité nécessaire à l'établissement d'une communication satisfaisante.

Le présent émetteur radio a été approuvé par Industrie Canada pour fonctionner avec les types d'antenne énumérés dans le manuel d'usage et ayant un gain admissible maximal et l'impédance requise pour chaque type d'antenne. Les types d'antenne non inclus dans cette liste, ou dont le gain est supérieur au gain maximal indiqué, sont strictement interdits pour l'exploitation de l'émetteur.

## **【Important Notice for Users of this Product in Japan】**

### **This development kit is NOT certified as Confirming to Technical Regulations of Radio Law of Japan**

If you use this product in Japan, you are required by Radio Law of Japan to follow the instructions below with respect to this product:

1. Use this product in a shielded room or any other test facility as defined in the notification #173 issued by Ministry of Internal Affairs and Communications on March 28, 2006, based on Sub-section 1.1 of Article 6 of the Ministry's Rule for Enforcement of Radio Law of Japan,
2. Use this product only after you obtained the license of Test Radio Station as provided in Radio Law of Japan with respect to this product, or
3. Use of this product only after you obtained the Technical Regulations Conformity Certification as provided in Radio Law of Japan with respect to this product. Also, please do not transfer this product, unless you give the same notice above to the transferee. Please note that if you could not follow the instructions above, you will be subject to penalties of Radio Law of Japan.

**Texas Instruments Japan Limited**  
**(address) 24-1, Nishi-Shinjuku 6 chome, Shinjuku-ku, Tokyo, Japan**

<http://www.tij.co.jp>

#### **【ご使用にあたっての注】**

本開発キットは技術基準適合証明を受けておりません。

本製品のご使用に際しては、電波法遵守のため、以下のいずれかの措置を取っていただく必要がありますのでご注意ください。

1. 電波法施行規則第6条第1項第1号に基づく平成18年3月28日総務省告示第173号で定められた電波暗室等の試験設備でご使用いただく。
2. 実験局の免許を取得後ご使用いただく。
3. 技術基準適合証明を取得後ご使用いただく。

なお、本製品は、上記の「ご使用にあたっての注意」を譲渡先、移転先に通知しない限り、譲渡、移転できないものとします。

上記を遵守頂けない場合は、電波法の罰則が適用される可能性があることをご留意ください。

日本テキサス・インスツルメンツ株式会社  
東京都新宿区西新宿6丁目24番1号  
西新宿三井ビル

<http://www.tij.co.jp>

## **EVALUATION BOARD/KIT/MODULE (EVM) WARNINGS, RESTRICTIONS AND DISCLAIMERS**

**For Feasibility Evaluation Only, in Laboratory/Development Environments.** Unless otherwise indicated, this EVM is not a finished electrical equipment and not intended for consumer use. It is intended solely for use for preliminary feasibility evaluation in laboratory/development environments by technically qualified electronics experts who are familiar with the dangers and application risks associated with handling electrical mechanical components, systems and subsystems. It should not be used as all or part of a finished end product.

Your Sole Responsibility and Risk. You acknowledge, represent and agree that:

1. You have unique knowledge concerning Federal, State and local regulatory requirements (including but not limited to Food and Drug Administration regulations, if applicable) which relate to your products and which relate to your use (and/or that of your employees, affiliates, contractors or designees) of the EVM for evaluation, testing and other purposes.
2. You have full and exclusive responsibility to assure the safety and compliance of your products with all such laws and other applicable regulatory requirements, and also to assure the safety of any activities to be conducted by you and/or your employees, affiliates, contractors or designees, using the EVM. Further, you are responsible to assure that any interfaces (electronic and/or mechanical) between the EVM and any human body are designed with suitable isolation and means to safely limit accessible leakage currents to minimize the risk of electrical shock hazard.
3. You will employ reasonable safeguards to ensure that your use of the EVM will not result in any property damage, injury or death, even if the EVM should fail to perform as described or expected.
4. You will take care of proper disposal and recycling of the EVM's electronic components and packing materials.

**Certain Instructions.** It is important to operate this EVM within TI's recommended specifications and environmental considerations per the user guidelines. Exceeding the specified EVM ratings (including but not limited to input and output voltage, current, power, and environmental ranges) may cause property damage, personal injury or death. If there are questions concerning these ratings please contact a TI field representative prior to connecting interface electronics including input power and intended loads. Any loads applied outside of the specified output range may result in unintended and/or inaccurate operation and/or possible permanent damage to the EVM and/or interface electronics. Please consult the EVM User's Guide prior to connecting any load to the EVM output. If there is uncertainty as to the load specification, please contact a TI field representative. During normal operation, some circuit components may have case temperatures greater than 60°C as long as the input and output are maintained at a normal ambient operating temperature. These components include but are not limited to linear regulators, switching transistors, pass transistors, and current sense resistors which can be identified using the EVM schematic located in the EVM User's Guide. When placing measurement probes near these devices during normal operation, please be aware that these devices may be very warm to the touch. As with all electronic evaluation tools, only qualified personnel knowledgeable in electronic measurement and diagnostics normally found in development environments should use these EVMs.

**Agreement to Defend, Indemnify and Hold Harmless.** You agree to defend, indemnify and hold TI, its licensors and their representatives harmless from and against any and all claims, damages, losses, expenses, costs and liabilities (collectively, "Claims") arising out of or in connection with any use of the EVM that is not in accordance with the terms of the agreement. This obligation shall apply whether Claims arise under law of tort or contract or any other legal theory, and even if the EVM fails to perform as described or expected.

**Safety-Critical or Life-Critical Applications.** If you intend to evaluate the components for possible use in safety critical applications (such as life support) where a failure of the TI product would reasonably be expected to cause severe personal injury or death, such as devices which are classified as FDA Class III or similar classification, then you must specifically notify TI of such intent and enter into a separate Assurance and Indemnity Agreement.

Mailing Address: Texas Instruments, Post Office Box 655303, Dallas, Texas 75265  
Copyright © 2013, Texas Instruments Incorporated

## IMPORTANT NOTICE

Texas Instruments Incorporated and its subsidiaries (TI) reserve the right to make corrections, enhancements, improvements and other changes to its semiconductor products and services per JESD46, latest issue, and to discontinue any product or service per JESD48, latest issue. Buyers should obtain the latest relevant information before placing orders and should verify that such information is current and complete. All semiconductor products (also referred to herein as "components") are sold subject to TI's terms and conditions of sale supplied at the time of order acknowledgment.

TI warrants performance of its components to the specifications applicable at the time of sale, in accordance with the warranty in TI's terms and conditions of sale of semiconductor products. Testing and other quality control techniques are used to the extent TI deems necessary to support this warranty. Except where mandated by applicable law, testing of all parameters of each component is not necessarily performed.

TI assumes no liability for applications assistance or the design of Buyers' products. Buyers are responsible for their products and applications using TI components. To minimize the risks associated with Buyers' products and applications, Buyers should provide adequate design and operating safeguards.

TI does not warrant or represent that any license, either express or implied, is granted under any patent right, copyright, mask work right, or other intellectual property right relating to any combination, machine, or process in which TI components or services are used. Information published by TI regarding third-party products or services does not constitute a license to use such products or services or a warranty or endorsement thereof. Use of such information may require a license from a third party under the patents or other intellectual property of the third party, or a license from TI under the patents or other intellectual property of TI.

Reproduction of significant portions of TI information in TI data books or data sheets is permissible only if reproduction is without alteration and is accompanied by all associated warranties, conditions, limitations, and notices. TI is not responsible or liable for such altered documentation. Information of third parties may be subject to additional restrictions.

Resale of TI components or services with statements different from or beyond the parameters stated by TI for that component or service voids all express and any implied warranties for the associated TI component or service and is an unfair and deceptive business practice. TI is not responsible or liable for any such statements.

Buyer acknowledges and agrees that it is solely responsible for compliance with all legal, regulatory and safety-related requirements concerning its products, and any use of TI components in its applications, notwithstanding any applications-related information or support that may be provided by TI. Buyer represents and agrees that it has all the necessary expertise to create and implement safeguards which anticipate dangerous consequences of failures, monitor failures and their consequences, lessen the likelihood of failures that might cause harm and take appropriate remedial actions. Buyer will fully indemnify TI and its representatives against any damages arising out of the use of any TI components in safety-critical applications.

In some cases, TI components may be promoted specifically to facilitate safety-related applications. With such components, TI's goal is to help enable customers to design and create their own end-product solutions that meet applicable functional safety standards and requirements. Nonetheless, such components are subject to these terms.

No TI components are authorized for use in FDA Class III (or similar life-critical medical equipment) unless authorized officers of the parties have executed a special agreement specifically governing such use.

Only those TI components which TI has specifically designated as military grade or "enhanced plastic" are designed and intended for use in military/aerospace applications or environments. Buyer acknowledges and agrees that any military or aerospace use of TI components which have **not** been so designated is solely at the Buyer's risk, and that Buyer is solely responsible for compliance with all legal and regulatory requirements in connection with such use.

TI has specifically designated certain components as meeting ISO/TS16949 requirements, mainly for automotive use. In any case of use of non-designated products, TI will not be responsible for any failure to meet ISO/TS16949.

### Products

Audio	<a href="http://www.ti.com/audio">www.ti.com/audio</a>
Amplifiers	<a href="http://amplifier.ti.com">amplifier.ti.com</a>
Data Converters	<a href="http://dataconverter.ti.com">dataconverter.ti.com</a>
DLP® Products	<a href="http://www.dlp.com">www.dlp.com</a>
DSP	<a href="http://dsp.ti.com">dsp.ti.com</a>
Clocks and Timers	<a href="http://www.ti.com/clocks">www.ti.com/clocks</a>
Interface	<a href="http://interface.ti.com">interface.ti.com</a>
Logic	<a href="http://logic.ti.com">logic.ti.com</a>
Power Mgmt	<a href="http://power.ti.com">power.ti.com</a>
Microcontrollers	<a href="http://microcontroller.ti.com">microcontroller.ti.com</a>
RFID	<a href="http://www.ti-rfid.com">www.ti-rfid.com</a>
OMAP Applications Processors	<a href="http://www.ti.com/omap">www.ti.com/omap</a>
Wireless Connectivity	<a href="http://www.ti.com/wirelessconnectivity">www.ti.com/wirelessconnectivity</a>

### Applications

Automotive and Transportation	<a href="http://www.ti.com/automotive">www.ti.com/automotive</a>
Communications and Telecom	<a href="http://www.ti.com/communications">www.ti.com/communications</a>
Computers and Peripherals	<a href="http://www.ti.com/computers">www.ti.com/computers</a>
Consumer Electronics	<a href="http://www.ti.com/consumer-apps">www.ti.com/consumer-apps</a>
Energy and Lighting	<a href="http://www.ti.com/energy">www.ti.com/energy</a>
Industrial	<a href="http://www.ti.com/industrial">www.ti.com/industrial</a>
Medical	<a href="http://www.ti.com/medical">www.ti.com/medical</a>
Security	<a href="http://www.ti.com/security">www.ti.com/security</a>
Space, Avionics and Defense	<a href="http://www.ti.com/space-avionics-defense">www.ti.com/space-avionics-defense</a>
Video and Imaging	<a href="http://www.ti.com/video">www.ti.com/video</a>

### TI E2E Community

[e2e.ti.com](http://e2e.ti.com)