

Table of Contents

1 Features	1	8 Device and Documentation Support	6
2 Applications	1	8.1 Receiving Notification of Documentation Updates ...	6
3 Description	1	8.2 Community Resources	6
4 Revision History	2	8.3 Trademarks	6
5 Pin Configuration and Functions	3	8.4 Electrostatic Discharge Caution	6
6 Specifications	4	8.5 Glossary	6
6.1 Absolute Maximum Ratings	4	9 Mechanical, Packaging, and Orderable Information	7
6.2 ESD Ratings	4	9.1 Mechanical Drawing	7
6.3 Recommended Operating Conditions	4	9.2 Recommended PCB Land Pattern	8
7 Application Schematic	5	9.3 Recommended Stencil Opening	9

4 Revision History

Changes from Original (March 2017) to Revision A	Page
• Updated <i>Mechanical Drawing</i> section	7

5 Pin Configuration and Functions

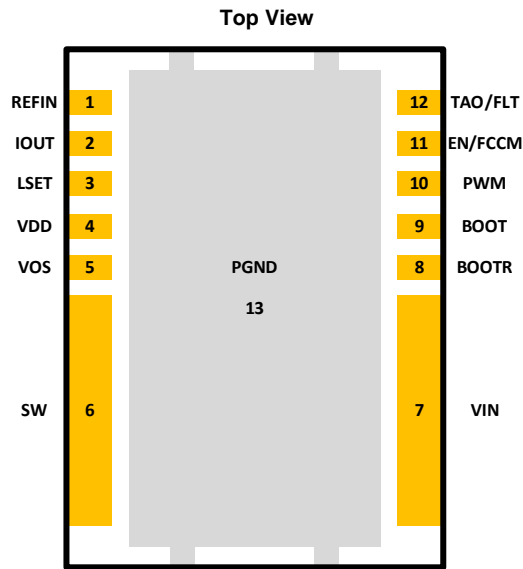

Pin Functions

PIN		DESCRIPTION
NAME	NO.	
REFIN	1	External reference voltage input for current sensing amplifier.
IOUT	2	Output of current sensing amplifier. $V(IOUT) - V(REFIN)$ is proportional to the phase current.
LSET	3	A resistor from this pin to PGND pin sets the inductor value for the internal current sensing circuitry.
VDD	4	Supply voltage for gate drivers and internal circuitry.
VOS	5	Output voltage sensing pin for the internal current sensing circuitry.
SW	6	Phase node connecting the HS MOSFET source and LS MOSFET drain – pin connection to the output inductor.
VIN	7	Input voltage pin. Connect input capacitors close to this pin.
BOOTR	8	Return path for HS gate driver. It is connected to VSW internally.
BOOT	9	Bootstrap capacitor connection. Connect a minimum 0.1- μ F, 16-V, X5R ceramic cap from BOOT to BOOTR pins. The bootstrap capacitor provides the charge to turn on the control FET. The bootstrap diode is integrated.
PWM	10	Tri-state input from external controller. Logic low sets control FET gate low and sync FET gate high. Logic high sets control FET gate high and sync FET gate low. Both MOSFET gates are set low if PWM stays in Hi-Z for greater than the tri-state shutdown hold-off time (t_{3HT}).
EN/FCCM	11	This dual function pin either enables the diode emulation function or can be used as a simple enable for the device. When this pin is driven into the tri-state window and held there for more than the tri-state holdoff time, Diode Emulation Mode (DEM) is enabled for sync FET. When the pin is high, device operates in Forced Continuous Conduction Mode (FCCM). When the pin is low, both FETs are held off. An internal resistor pulls this pin low if left floating.
TAO/FAULT	12	Temperature Amplifier Output. Reports a voltage proportional to the IC temperature. An ORing diode is integrated in the IC. When used in multiphase application, a single wire can be used to connect the TAO pins of all the ICs. Only the highest temperature will be reported. TAO will be pulled up to 3.3 V if thermal shutdown, LSOC, or HSS detection circuit is tripped.
PGND	13	Power ground.

6 Specifications

6.1 Absolute Maximum Ratings

 $T_A = 25^\circ\text{C}$ (unless otherwise stated)⁽¹⁾

	MIN	MAX	UNIT
V_{IN} to P_{GND}	-0.3	20	V
V_{IN} to V_{SW}	-0.3	20	V
V_{IN} to V_{SW} (10 ns)		23	V
V_{SW} to P_{GND}	-0.3	20	V
V_{SW} to P_{GND} (10 ns)	-7	23	V
V_{DD} to P_{GND}	-0.3	7	V
EN/FCCM, TAO/FLT, LSET to P_{GND} ⁽²⁾	-0.3	$V_{DD} + 0.3$	V
IOUT, VOS, PWM to P_{GND}	-0.3	7	V
REFIN	-0.3	3.6	V
BOOT to BOOTR ⁽²⁾	-0.3	$V_{DD} + 0.3$	V
BOOT to P_{GND}	-0.3	30	V
T_J Operating junction temperature	-55	150	$^\circ\text{C}$
T_{stg} Storage temperature	-55	150	$^\circ\text{C}$

- (1) Stresses beyond those listed under *Absolute Maximum Ratings* may cause permanent damage to the device. These are stress ratings only, and functional operation of the device at these or any other conditions beyond those indicated in the *Recommended Operating Conditions* is not implied. Exposure to absolute-maximum-rated conditions for extended periods may affect device reliability.
- (2) Should not exceed 7 V.

6.2 ESD Ratings

	VALUE	UNIT
$V_{(ESD)}$ Electrostatic discharge	Human-body model (HBM)	± 2000
	Charged-device model (CDM)	± 500

6.3 Recommended Operating Conditions

 $T_A = 25^\circ\text{C}$ (unless otherwise stated)

PARAMETER	CONDITIONS	MIN	MAX	UNIT
V_{DD} Driver supply voltage		4.5	5.5	V
V_{IN} Input supply voltage ⁽¹⁾		4.5	16	V
V_{OUT} Output voltage			5.5	V
PWM PWM to P_{GND}			$V_{DD} + 0.3$	V
I_{OUT} Continuous output current	$V_{IN} = 12\text{ V}$, $V_{DD} = 5\text{ V}$, $V_{OUT} = 1.2\text{ V}$, $f_{SW} = 500\text{ kHz}$ ⁽²⁾		75	A
I_{OUT-PK} Peak output current ⁽³⁾			105	A
f_{SW} Switching frequency	$C_{BST} = 0.1\ \mu\text{F}$ (min), $V_{OUT} = 2.5\text{ V}$ (max)		1250	kHz
On-time duty cycle	$f_{SW} = 1\text{ MHz}$		85%	
Minimum PWM on-time		20		ns
Operating junction temperature		-40	125	$^\circ\text{C}$

- (1) Operating at high V_{IN} can create excessive AC voltage overshoots on the switch node (V_{SW}) during MOSFET switching transients. For reliable operation, the switch node (V_{SW}) to ground voltage must remain at or below the *Absolute Maximum Ratings*.
- (2) Measurement made with six 10- μF (TDK C3216X7R1C106KT or equivalent) ceramic capacitors across V_{IN} to P_{GND} pins.
- (3) System conditions as defined in Note 2. Peak output current is applied for $t_p = 50\ \mu\text{s}$.

7 Application Schematic

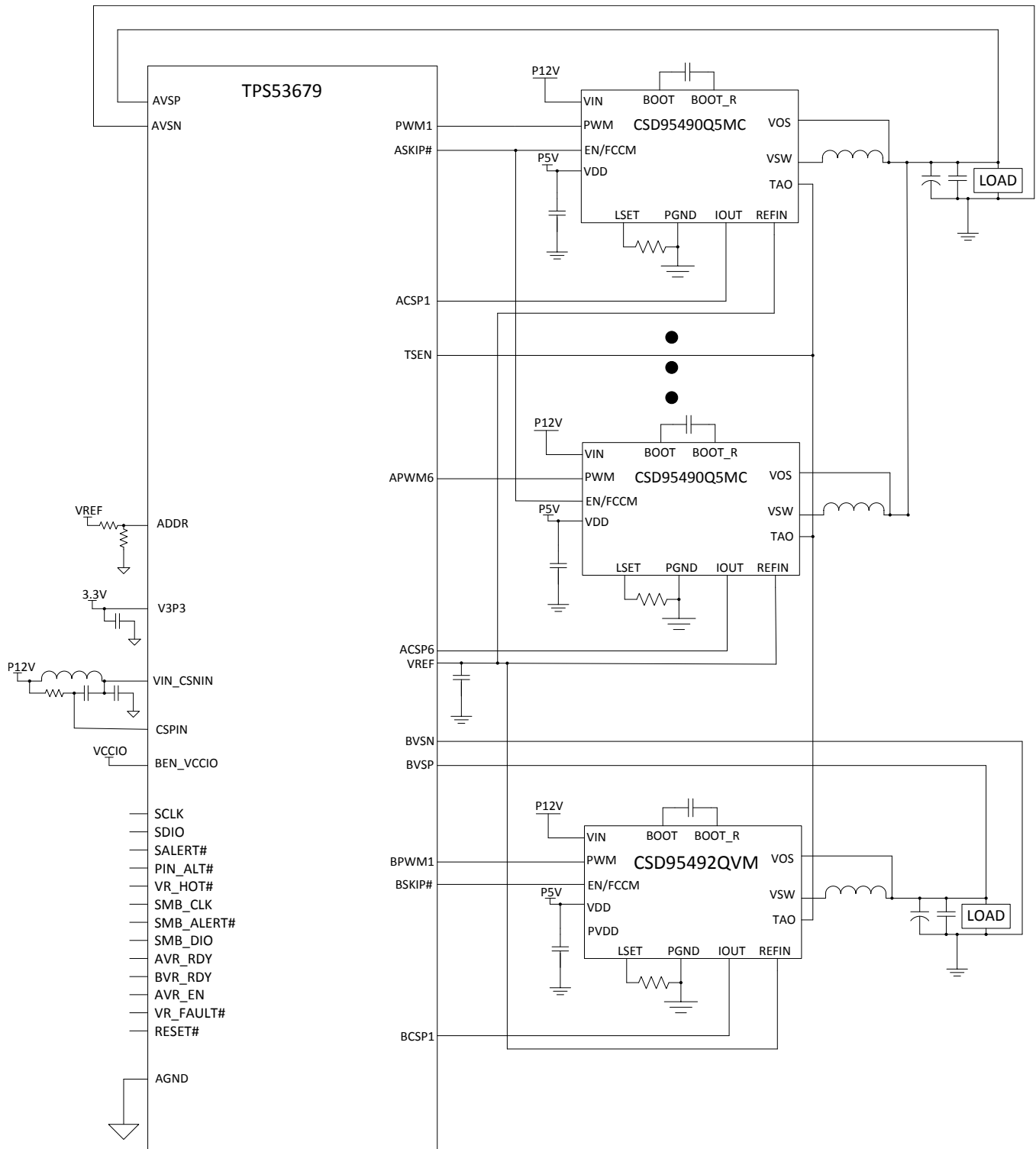

Copyright © 2016, Texas Instruments Incorporated

Figure 1. Application Schematic

Note: The schematic in [Figure 1](#) is a conceptual drawing only. Actual designs may require additional components not shown.

8 Device and Documentation Support

8.1 Receiving Notification of Documentation Updates

To receive notification of documentation updates, navigate to the device product folder on ti.com. In the upper right corner, click on *Alert me* to register and receive a weekly digest of any product information that has changed. For change details, review the revision history included in any revised document.

8.2 Community Resources

The following links connect to TI community resources. Linked contents are provided "AS IS" by the respective contributors. They do not constitute TI specifications and do not necessarily reflect TI's views; see TI's [Terms of Use](#).

TI E2E™ Online Community *TI's Engineer-to-Engineer (E2E) Community*. Created to foster collaboration among engineers. At e2e.ti.com, you can ask questions, share knowledge, explore ideas and help solve problems with fellow engineers.

Design Support *TI's Design Support* Quickly find helpful E2E forums along with design support tools and contact information for technical support.

8.3 Trademarks

NexFET, E2E are trademarks of Texas Instruments.
All other trademarks are the property of their respective owners.

8.4 Electrostatic Discharge Caution



These devices have limited built-in ESD protection. The leads should be shorted together or the device placed in conductive foam during storage or handling to prevent electrostatic damage to the MOS gates.

8.5 Glossary

[SLYZ022](#) — *TI Glossary*.

This glossary lists and explains terms, acronyms, and definitions.

9 Mechanical, Packaging, and Orderable Information

The following pages include mechanical, packaging, and orderable information. This information is the most current data available for the designated devices. This data is subject to change without notice and revision of this document. For browser-based versions of this data sheet, refer to the left-hand navigation.

9.1 Mechanical Drawing

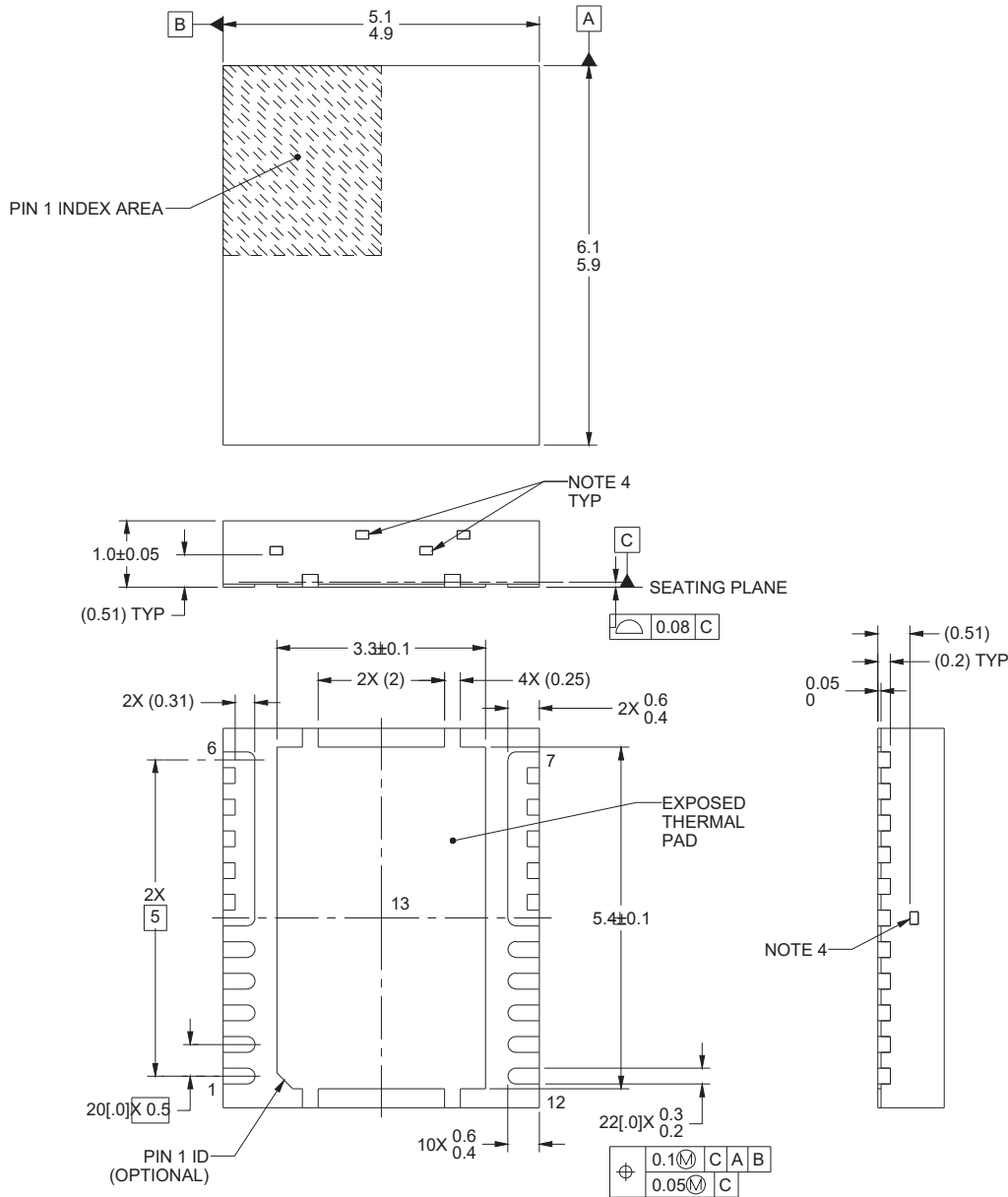

1. All linear dimensions are in millimeters. Any dimensions in parenthesis are for reference only. Dimensioning and tolerancing per ASME Y14.5M.
2. This drawing is subject to change without notice.
3. The package thermal pads must be soldered to the printed circuit board for thermal and mechanical performance.
4. Exposed tie bar features may vary.

9.2 Recommended PCB Land Pattern

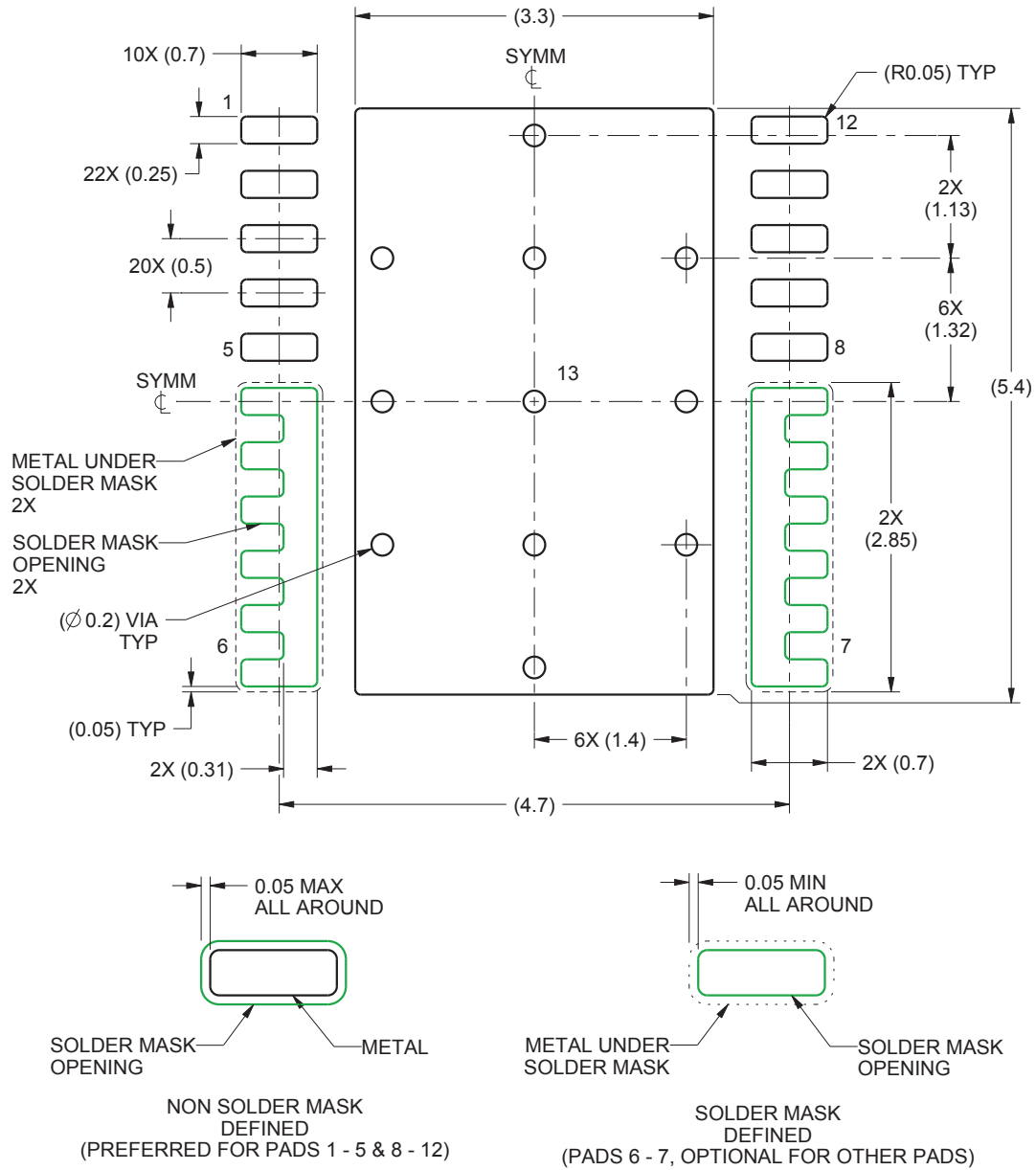

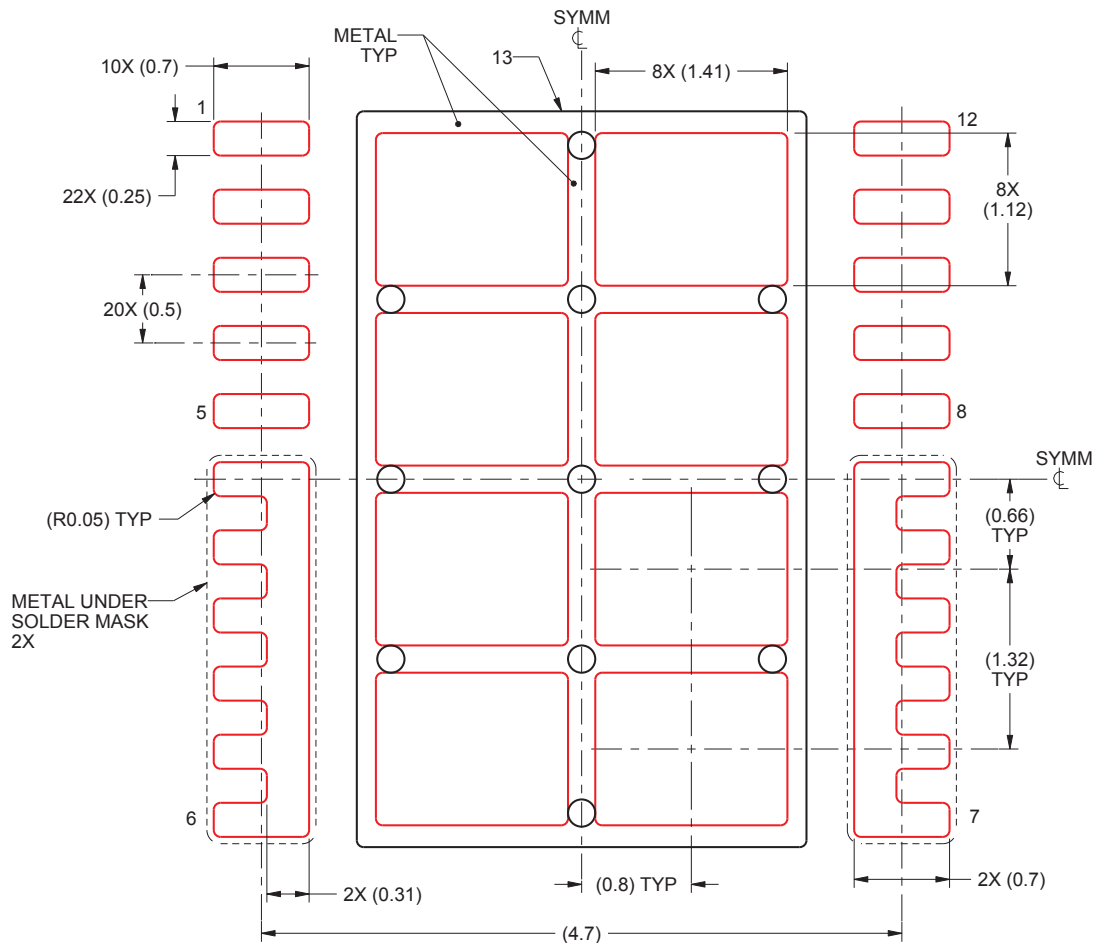

1. All linear dimensions are in millimeters. Any dimensions in parenthesis are for reference only. Dimensioning and tolerancing per ASME Y14.5M.
2. This drawing is subject to change without notice.
3. This package is designed to be soldered to thermal pads on the board. For more information, see [QFN/SON PCB Attachment \(SLUA271\)](#).
4. Vias are optional depending on application, refer to device data sheet. If any vias are implemented, refer to their locations shown on this view. It is recommended that vias under paste be filled, plugged or tented.

9.3 Recommended Stencil Opening



1. All linear dimensions are in millimeters. Any dimensions in parenthesis are for reference only. Dimensioning and tolerancing per ASME Y14.5M.
2. This drawing is subject to change without notice.
3. Laser cutting apertures with trapezoidal walls and rounded corners may offer better paste release. IPC-7525 may have alternate design recommendations.

PACKAGING INFORMATION

Orderable Device	Status (1)	Package Type	Package Drawing	Pins	Package Qty	Eco Plan (2)	Lead finish/ Ball material (6)	MSL Peak Temp (3)	Op Temp (°C)	Device Marking (4/5)	Samples
CSD95490Q5MC	ACTIVE	VSON-CLIP	DMC	12	2500	RoHS-Exempt & Green	SN	Level-2-260C-1 YEAR	-55 to 150	95490MC	
CSD95490Q5MCT	ACTIVE	VSON-CLIP	DMC	12	250	RoHS-Exempt & Green	SN	Level-2-260C-1 YEAR	-55 to 150	95490MC	

(1) The marketing status values are defined as follows:

ACTIVE: Product device recommended for new designs.

LIFEBUY: TI has announced that the device will be discontinued, and a lifetime-buy period is in effect.

NRND: Not recommended for new designs. Device is in production to support existing customers, but TI does not recommend using this part in a new design.

PREVIEW: Device has been announced but is not in production. Samples may or may not be available.

OBSOLETE: TI has discontinued the production of the device.

(2) **RoHS:** TI defines "RoHS" to mean semiconductor products that are compliant with the current EU RoHS requirements for all 10 RoHS substances, including the requirement that RoHS substance do not exceed 0.1% by weight in homogeneous materials. Where designed to be soldered at high temperatures, "RoHS" products are suitable for use in specified lead-free processes. TI may reference these types of products as "Pb-Free".

RoHS Exempt: TI defines "RoHS Exempt" to mean products that contain lead but are compliant with EU RoHS pursuant to a specific EU RoHS exemption.

Green: TI defines "Green" to mean the content of Chlorine (Cl) and Bromine (Br) based flame retardants meet JS709B low halogen requirements of <=1000ppm threshold. Antimony trioxide based flame retardants must also meet the <=1000ppm threshold requirement.

(3) MSL, Peak Temp. - The Moisture Sensitivity Level rating according to the JEDEC industry standard classifications, and peak solder temperature.

(4) There may be additional marking, which relates to the logo, the lot trace code information, or the environmental category on the device.

(5) Multiple Device Markings will be inside parentheses. Only one Device Marking contained in parentheses and separated by a "~" will appear on a device. If a line is indented then it is a continuation of the previous line and the two combined represent the entire Device Marking for that device.

(6) Lead finish/Ball material - Orderable Devices may have multiple material finish options. Finish options are separated by a vertical ruled line. Lead finish/Ball material values may wrap to two lines if the finish value exceeds the maximum column width.

Important Information and Disclaimer:The information provided on this page represents TI's knowledge and belief as of the date that it is provided. TI bases its knowledge and belief on information provided by third parties, and makes no representation or warranty as to the accuracy of such information. Efforts are underway to better integrate information from third parties. TI has taken and continues to take reasonable steps to provide representative and accurate information but may not have conducted destructive testing or chemical analysis on incoming materials and chemicals. TI and TI suppliers consider certain information to be proprietary, and thus CAS numbers and other limited information may not be available for release.

In no event shall TI's liability arising out of such information exceed the total purchase price of the TI part(s) at issue in this document sold by TI to Customer on an annual basis.

TAPE AND REEL INFORMATION



QUADRANT ASSIGNMENTS FOR PIN 1 ORIENTATION IN TAPE



*All dimensions are nominal

Device	Package Type	Package Drawing	Pins	SPQ	Reel Diameter (mm)	Reel Width W1 (mm)	A0 (mm)	B0 (mm)	K0 (mm)	P1 (mm)	W (mm)	Pin1 Quadrant
CSD95490Q5MC	VSON-CLIP	DMC	12	2500	330.0	12.4	5.3	6.3	1.2	8.0	12.0	Q1
CSD95490Q5MCT	VSON-CLIP	DMC	12	250	180.0	12.4	5.3	6.3	1.2	8.0	12.0	Q1

TAPE AND REEL BOX DIMENSIONS

*All dimensions are nominal

Device	Package Type	Package Drawing	Pins	SPQ	Length (mm)	Width (mm)	Height (mm)
CSD95490Q5MC	VSON-CLIP	DMC	12	2500	367.0	367.0	38.0
CSD95490Q5MCT	VSON-CLIP	DMC	12	250	213.0	191.0	35.0

IMPORTANT NOTICE AND DISCLAIMER

TI PROVIDES TECHNICAL AND RELIABILITY DATA (INCLUDING DATASHEETS), DESIGN RESOURCES (INCLUDING REFERENCE DESIGNS), APPLICATION OR OTHER DESIGN ADVICE, WEB TOOLS, SAFETY INFORMATION, AND OTHER RESOURCES "AS IS" AND WITH ALL FAULTS, AND DISCLAIMS ALL WARRANTIES, EXPRESS AND IMPLIED, INCLUDING WITHOUT LIMITATION ANY IMPLIED WARRANTIES OF MERCHANTABILITY, FITNESS FOR A PARTICULAR PURPOSE OR NON-INFRINGEMENT OF THIRD PARTY INTELLECTUAL PROPERTY RIGHTS.

These resources are intended for skilled developers designing with TI products. You are solely responsible for (1) selecting the appropriate TI products for your application, (2) designing, validating and testing your application, and (3) ensuring your application meets applicable standards, and any other safety, security, or other requirements. These resources are subject to change without notice. TI grants you permission to use these resources only for development of an application that uses the TI products described in the resource. Other reproduction and display of these resources is prohibited. No license is granted to any other TI intellectual property right or to any third party intellectual property right. TI disclaims responsibility for, and you will fully indemnify TI and its representatives against, any claims, damages, costs, losses, and liabilities arising out of your use of these resources.

TI's products are provided subject to TI's Terms of Sale (<https://www.ti.com/legal/termsofsale.html>) or other applicable terms available either on [ti.com](https://www.ti.com) or provided in conjunction with such TI products. TI's provision of these resources does not expand or otherwise alter TI's applicable warranties or warranty disclaimers for TI products.

Mailing Address: Texas Instruments, Post Office Box 655303, Dallas, Texas 75265
Copyright © 2021, Texas Instruments Incorporated