



The Infinite Bandwidth Company™

MIC4826/4827 Evaluation Board

High Voltage EL Driver

By William Mai

General Description

The MIC4826 and MIC4827 are high voltage EL (Electroluminescent) drivers designed for driving EL lamps of up to 6 in² (typically). The input supply voltage range is from 1.8V to 5.5V, making both devices suitable for one-cell Li-Ion and two-cell NiCad/NiMH/Alkaline applications. Both devices use a single inductor and a minimum number of passive components. The nominal AC output voltage that is applied to the EL lamp is 160V for the MIC4826 and 180V for MIC4827. The chip can be enabled or disabled by connecting the resistor on R_{SW} and R_{EL} to V_{DD} or ground, respectively.

The MIC4826/7 feature separately programmable switch frequency and EL frequency through external resistors. This allows the user to optimize the efficiency and enhance the brightness of the lamps.

Requirements

The MIC4826/7 evaluation board requires an input power source which should be able to supply a minimum of 0.5A and a maximum voltage of 5.5V.

Precautions

The evaluation board does not have input reverse polarity protection. Applying a negative voltage at the V_{IN} terminal (with respect to ground) may permanently damage the components on the board.

The input capacitor voltage's rating is 6.3V. Exceeding this voltage for an extended period of time will damage the capacitor. The C_{OUT} capacitor is rated at 100V. Do not exceed 100V.

Circuit Operation

The MIC4826/7 are essentially comprised of two parts, a boost converter and an H-bridge driver. The boost converter steps up the input voltage to 80V (typical) for the MIC4826 and 90V (typical) for the MIC4827. The H-bridge driver produces an AC voltage of 160V_{PP} (typical) for the MIC4826 and 180V_{PP} (typical) for the MIC4827 to drive the EL lamp at a frequency that is programmed by the resistor on R_{EL}.

Schematic

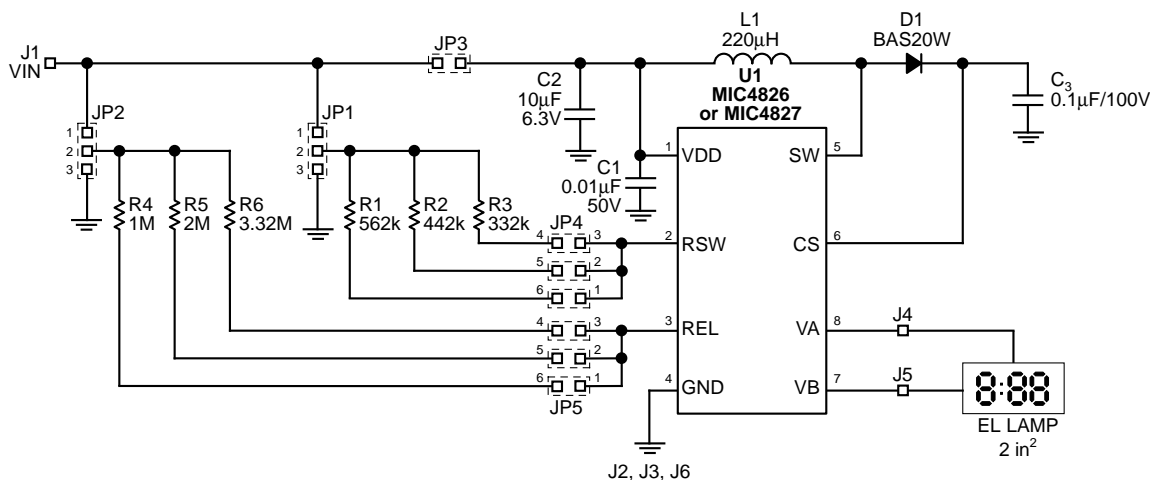

Figure 1. High Voltage EL Driver Evaluation Board

EL Frequency Setting

Three EL frequencies may be selected by placing the shorting jumper across the proper pins of header JP5 (108Hz, 180Hz or 360Hz). The EL frequency determines the color of the EL lamp. In general, increasing the EL lamp frequency will increase the input current. See Tables 1 and 2.

Switching Frequency Setting

Three switching frequencies may be selected by placing the shorting jumper across the pins of header JP4 (64KHz, 81KHz or 108KHz). Tables 1 and 2 show the relationship between the switching frequency, the input voltage range, input current range, and the EL lamp frequency.

Enable/Disable

Connecting JP1 and JP2 to V_{IN} enables the EL driver. Connecting JP1 and JP2 to GND disables the EL driver.

Output Capacitor

Both the output capacitance and the capacitor's ESR (equivalent series resistance) affect the output ripple. The ESR mainly contributes to the high frequency output ripple while the capacitance contributes to the low frequency output ripple. In this evaluation board, a 0.1 μ F/100V ceramic output capacitor is used for wide input voltage range applications. A narrow input voltage range such as the Li-Ion battery range (3.0V to 4.2V) can use a small output capacitor, 0.01 μ F/100V.

Diode

The BAS20W is used for this evaluation board. It has 100nA maximum peak reverse current at 150V in SOT-323 package. For cost-sensitive applications, a lower reverse-voltage rated diode may be used.

f_{EL}	R_{EL}	f_{sw}	R_{sw}	$V_{IN}(MIN)$	$V_{IN}(MAX)$	Input Current Range
(Hz)	(M Ω)	(KHz)	(K Ω)	(V)	(V)	(mA)
108	3.32	64	562	1.8	5.5	8-32
180	2	64	562	2.2	5.5	12-33
360	1	64	562	2.8	5.5	21-42
108	3.32	81	442	2.0	5.5	8-29
180	2	81	442	2.3	5.5	12-32
360	1	81	442	2.9	5.5	20-40
108	3.32	108	332	2.4	5.5	8-24
180	2	108	332	2.7	5.5	12-28
360	1	108	332	3.2	5.5	20-37

Table 1. Typical MIC4826 Performance for 160V_{pp} Output

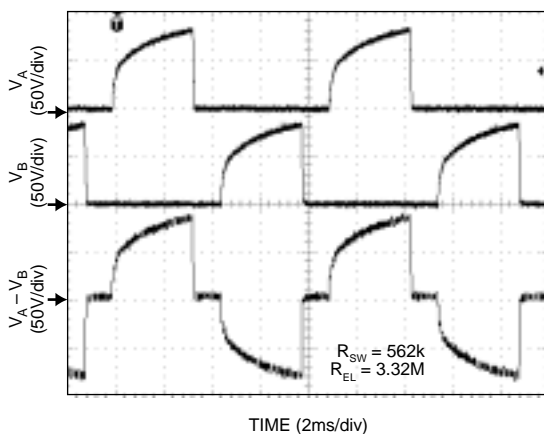

Figure 1. Typical MIC4826 Output Waveform for $V_{IN} = 1.8V$

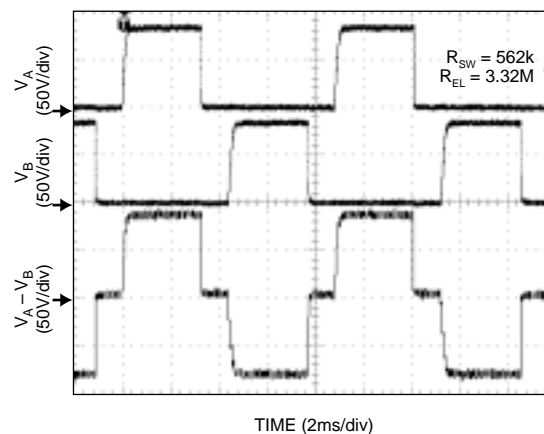

Figure 2. Typical MIC4826 Output Waveform for $V_{IN} = 5.5V$

f_{EL}	R_{EL}	f_{SW}	R_{SW}	$V_{IN}(MIN)$	$V_{IN}(MAX)$	Input Current Range
(Hz)	(M Ω)	(KHz)	(K Ω)	(V)	(V)	(mA)
108	3.32	64	562	2	5.5	7-36
180	2	64	562	2.3	5.5	9-41
360	1	64	562	3.1	5.5	27-48
108	3.32	81	442	2.2	5.5	7-34
180	2	81	442	2.5	5.5	16-39
360	1	81	442	3.2	5.5	27-47
108	3.32	108	332	2.7	5.5	8-27
180	2	108	332	3	5.5	10-32
360	1	108	332	3.6	5.5	26-41

Table 2. Typical MIC4827 Performance for 180V_{pp} Output

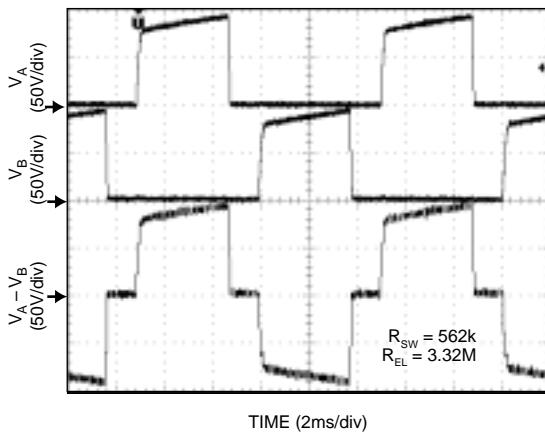

Figure 3. Typical MIC4827 Output Waveform for $V_{IN} = 2.0V$

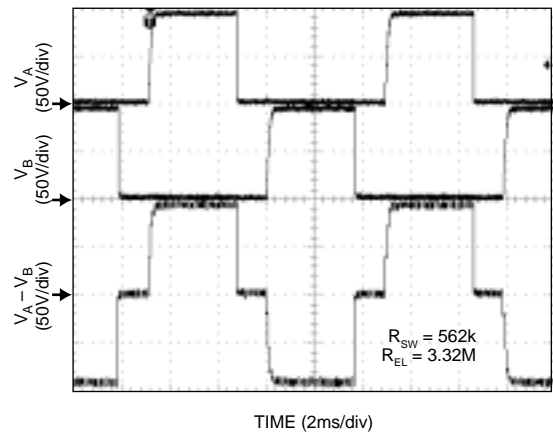
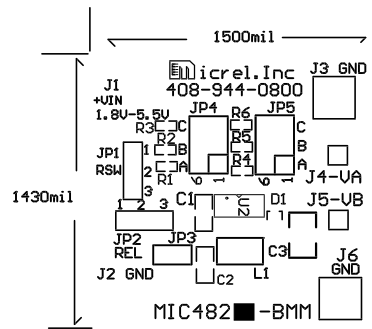
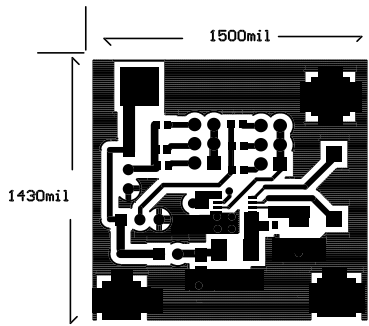

Figure 4. Typical MIC4827 Output Waveform for $V_{IN} = 5.5V$

Printed Circuit Board



Top Side Silk Screen



Top Side Copper

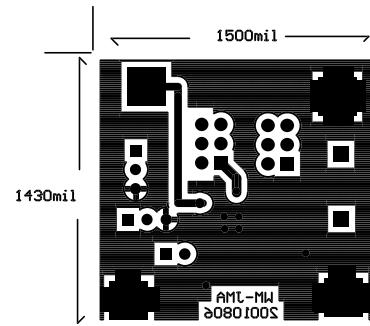

Bottom Side Copper

Bill of Materials

Item	Part Number	Manufacturer	Description	Qty
U1	MIC4826BMM or MIC4827BMM	Micrel ¹	High Voltage EL Driver	1
D1	BAS20W	Diodes, Inc. ²	Diode	1
L1	LQH43CN221K01L	Murata ³	220 μ H Inductor	1
C1	GRM39 X7R 103K 50	Murata ³	0.01 μ F, 50V Ceramic	1
C2	GRM40 X5R 106K 6.3	Murata ³	10 μ F, 6.3V Ceramic	1
C3	GRM42-2 X7R 104K 100	Murata ³	0.1 μ F, 100V Ceramic	1
R1	CRCW 0603 5623 FRT1	Vishay-Dale ⁴	562K 1%, 0603 size resistor	1
R2	CRCW 0603 4423 FRT1	Vishay-Dale ⁴	442K 1%, 0603 size resistor	1
R3	CRCW 0603 3323 FRT1	Vishay-Dale ⁴	332K 1%, 0603 size resistor	1
R4	CRCW 0603 1004 FRT1	Vishay-Dale ⁴	1M 1%, 0603 size resistor	1
R5	CRCW 0603 2004 FRT1	Vishay-Dale ⁴	2M 1%, 0603 size resistor	1
R6	CRCW 0603 3324 FRT1	Vishay-Dale ⁴	3.32M 1%, 0603 size resistor	1
JP1,JP2		Sullins	Jumpers	2 set of 6
JP3		Sullins	Jumper	1
JP4,P5	SNT-100-BL-G	Sullins	Jumpers	2 set of 3
J1,J2,J3,J6	2551-2-00-01-00-00-07-0	Milmax	Turret Pins	4
EL Lamp	X533-19	LSI ⁵	EL Lamp	1

1. Micrel Semiconductor, tel: 408-944-0800

2. Diodes, Inc., tel: 805-446-4800

3. Murata, tel: 800-831-9172

4. Vishay-Dale, tel: 206-452-5664

5. LSI, tel: 603-643-7766

MICREL INC. 1849 FORTUNE DRIVE SAN JOSE, CA 95131 USA

TEL + 1 (408) 944-0800 FAX + 1 (408) 944-0970 WEB <http://www.micrel.com>

This information is believed to be accurate and reliable, however no responsibility is assumed by Micrel for its use nor for any infringement of patents or other rights of third parties resulting from its use. No license is granted by implication or otherwise under any patent or patent right of Micrel Inc.

© 2001 Micrel Incorporated